

List of VM Consolidated documents of Dr. S. K. Kapoor

List 3 Different aspects of Vedic Mathematics

Article - 9

ASPECT OF VEDIC KNOWLEDGE

ASPECT OF VEDIC KNOWLEDGE

1. ASPECT-1 TRANSCENDENTAL BASE OF ASHTADHIYAI page 1 to 50
2. ASPECT-2 VEDIC MATHEMATICS FORMAT AND FORMAT OF MODERN MATHEMATICS pages 1 to 45
3. ASPECT-3 LETTER BY LETTER CHASE pages 1 to 43
4. ASPECT-4 VEDIC MATHEMATICS OF EXISTENCE PHENOMENON pages 1 to 34
5. ASPECT-5 120 YEAR CYCLE pages 1 to 17

TRANSCENDENTAL BASE OF ASHTADHEY

CONTENTS

1.	F-4 transcendental base	1-7
2.	F-5 maheshwara sutras	8-9
3.	F-6 melting mental state	10-17
4.	F-7 vm transcedental domain	18-22
5.	F-8 artifices of numbers & dimensional frames	23-30
6.	F-9 120 year cycle	31-35
7.	F-10 number value 111	36-39
8.	F-11 panch varitiya	40-42
9.	F-12 quadruple perfect number (6, 28, 496, 8128)	43-50
10.		

**VEDIC MATHEMATICS FORMAT
AND
FORMAT OF MODERN MATHEMATICS**

CONTENTS

1. Vedic Mathematics format & format of modern mathematics	1-5
2. Bindu Sarovar	6-15
3. Ardh Matra	16-24
4. Tri-Pundarm	25-30
5. Swastik Pada	31-34
6. Word Formulation Pinda	35-43
7. Devnagri Alphabet with TCV value	44-45

LETTER BY LETTER CHASE

CONTENT

1. Devnagri alphabet with TCV value	1-2
2. Ashtadhaiya format	3-11
3. Domains 1 to 9	12-15
4. Formulation Shruti	16-27
5. Drishta	28-35
6. Letter by letter Chase	36-43

VEDIC MATHEMATICS OF EXISTENCE PHENOMENON

CONTENT

- | | |
|--|-------|
| 1. Vedic Mathematics of existence phenomenon | 1-10 |
| 2. Self referral organization format | 11-16 |
| 3. Swapping self referral domain | 17-28 |
| 4. Number value 18 | 29-34 |

120 YEAR CYCLE

CONTENTS

1. Number value 120
2. Shad Chakra format
3. Geeta study zone
4. Transcendence spectrum of self referral origin
5. Number value 17
6. Number value 18

EK to NAV

CONTENTS

1. Formulation NAV to EK
2. Visphot Dhavani

TRANSCENDENTAL BASE OF ASHTADHEY

CONTENTS

11. F-4 transcendental base	1-7
12. F-5 maheshwara sutras	8-9
13. F-6 melting mental state	10-17
14. F-7 vm transcedental domain	18-22
15. F-8 artifices of numbers & dimensional frames	23-30
16. F-9 120 year cycle	31-35
17. F-10 number value 111	36-39
18. F-11 panch varitiya	40-42
19. F-12 quadruple perfect number (6, 28, 496, 8128)	43-50
20.	

TRANSCENDENTAL BASE

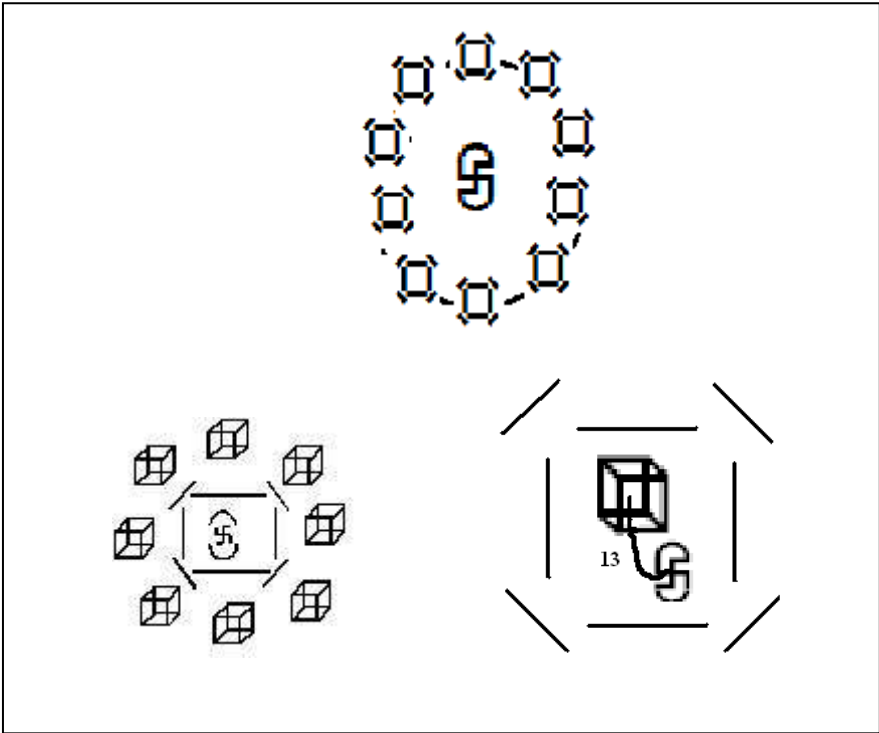

1. Transcendental base of manifested creation is the fifth fold of four folds manifestation layers.
2. Within creator's space (4-space), manifestations along format of idol of Lord Brahma are four folds manifestation layers of dimensional fold, boundary fold, domain fold and origin fold.

3. Creator's space (4-space) is of transcendental origin (5-space as origin).
4. 5-space plays the role of transcendental origin of 4-space.
5. 5-space plays the role of transcendental base, as fifth fold of four folds manifestation layers.
6. One may have a pause here and take note that 4-space plays the role of creative boundary of the transcendental domain (5-space domain).
7. Creator's space is of a spatial dimensional order while transcendental domain is of a solid dimensional order.
8. Within creator's space, solids have a degree of freedom of motion which manifests as 13th edge of 12 edge cube.
9. This 13th edge leads to and connects with the seat of transcendental origin of creator's space.

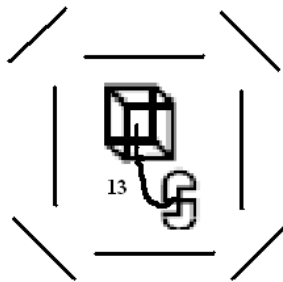

10. One may have a pause here and take note that 4-space is a spatial order space, and as such the 13th edge manifestation format is going to be of spatial format.
11. One shall glimpse and imbibe the above features and roles of 2-space content, 3-space content, 4-space content and 5-space content as spatial dimensional order of 4-space, solid

boundary of 3-space, creative domain of 4-space and transcendental origin of 4-space, together as four folds manifestation layer.

12. One may further have a pause here and take note that this simultaneous manifestation feature of 2-space content, 3-space content, 4-space content and 5-space content brings us face to face with the manifestation feature of manifestation phenomenon as of value $2+3+4+5 = 14$ and hyper cube 14 as four folds manifestation layer (12, 13, 14, 15) leads us to value $12+13+14+15 = 54$ which accepts organization as $54 = 14+40$ with value $14 = 2+3+4+5$, parallel to four folds manifestation layer (2, 3, 4, 5) of hyper cube 4 and $40 = 4 \times 10$ parallel to 40 coordinates fixation of creative boundary of ten Components of transcendental domain.
13. It would be blissful to take note that $54 = 27+27 = 3^3 + 3^3$ which is parallel to the set up of 27 nakshatras of northern hemisphere together with 27 nakshatras of southern hemisphere.
14. Further, hyper cube 14 is of $2 \times 14 + 1 = 29$ versions.
15. Still further, formulation Brahma accepts transcendental code value 29.
16. One shall sit comfortably and to permit the transcending mind to glimpse and imbibe format feature of idol of lord Brahma, being parallel to the format and features of hyper cube 4.
17. It would further be very blissful to permit the transcending mind to chase the way, with the grace of transcendental lord Shiv, lord Brahma multiplies as ten Brahmas within

transcendental domain and is of potential and virtues of creative boundary of ten Components of transcendental domain.

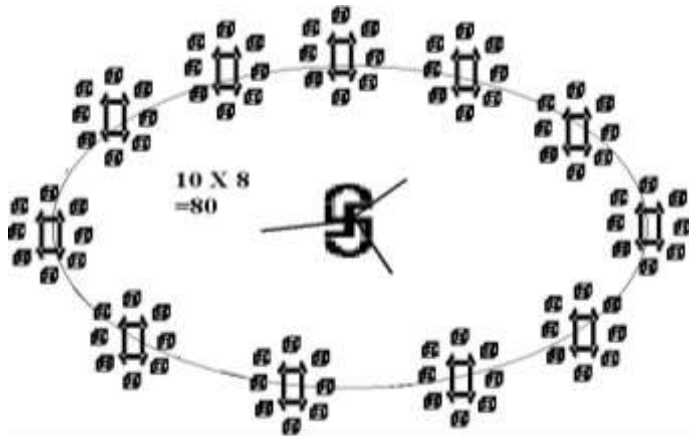

18. Sadhakas fulfilled with intensity of urge to glimpse and imbibe the values and features of transcendental based of

ashtadhiya shall sit comfortably and to permit the transcending mind to glimpse and imbibe the above values and features of quadruple space contents of 2, 3, 4, 5-spaces simultaneously manifesting as a four folds manifestation layer (2, 3, 4, 5) with the potentialities and features of re-manifestation as hyper cube 14 being a four folds manifestation layer (12, 13, 14, 15) with transcendental base fold being of value (16).

19. It would be blissful to visit and revisit five folds transcendence range (12, 13, 14, 15, 16) of summation value $12+13+14+15+16 = 70$.
20. One may have a pause here and take note that domain split spectrum is of sequential progression value (1, 2, 5, 12, 29, 70, ...).

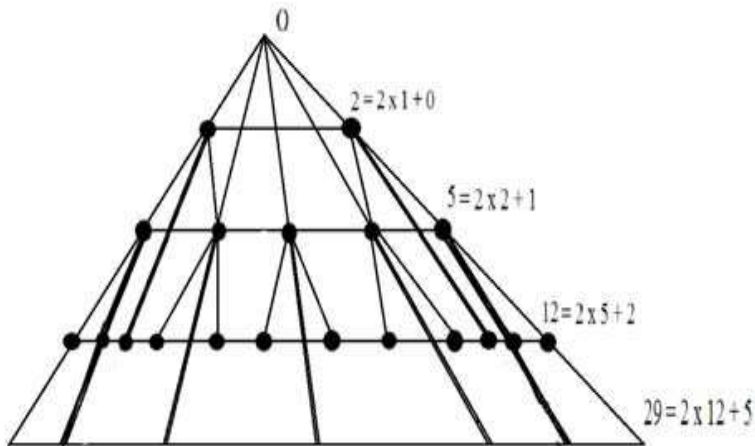

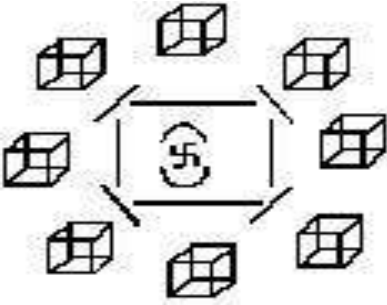

21. It would be a very blissful exercise to visit and revisit the format feature of hyper cube 4, idol of lord Brahma and domain split spectrum flow, which permit depiction and expression.



22. It would further be very blissful to take note that transcendence of solid order from the transcendental base of creator space shall be making the set up of 4 folds manifestation layer (2, 3, 4, 5) of summation value $2+3+4+5 = 14$ as of value $14 \times 3 = 42$, which accepts organization $(2+3+4+5+6)+(2)+(2+3+4+5+6)$ which is parallel to synthesis value of a pair of transcendence range of spatial order.

23. It is this feature which deserves to be comprehended well for its full appreciation for acquiring proper insight and for

attaining appropriate enlightenment of the organization
format of 14 Maheshwara sutras and 42 Pritiyaharas.



MAHESHWARA SUTRAS





MAHESHWARA SUTRAS WITH TCV

S.N.	Sutra	TCV value
1.	अ इ उ ष्	(1, 2, 3) (7)
2.	ऋ लृ क्	(4, 5) (1)
3.	ए ओ ङ्.	(6, 7) 5
4.	ऐ औ च्	(8, 9) (2)
5.	ह य व र ट	(9, 1, 7, 3) (3)
6.	ल ण्	(5) (7)
7.	ज म ङ् ण न ण्	(6, 9, 5, 7, 8) (9)
8.	झ भ ञ	(5, 8) (6)
9.	घ ढ ध ष्	(4, 7, 9) (6)
10.	ज ब ग ड द श्	(4, 7, 3, 5, 6) (2)

11.	ख फ छ ठ थ च ट त व्	(2, 6, 3, 4, 5, 2, 3, 4) (7)
12.	क प य	(1, 5) (1)
13.	श ष स र	(2, 6, 3) (3)
14.	ह ल्	(9) (5)

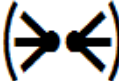

MELTING MENTAL STATES

Hyper cubes 1 to 6					
1	2	3	4	5	6
					

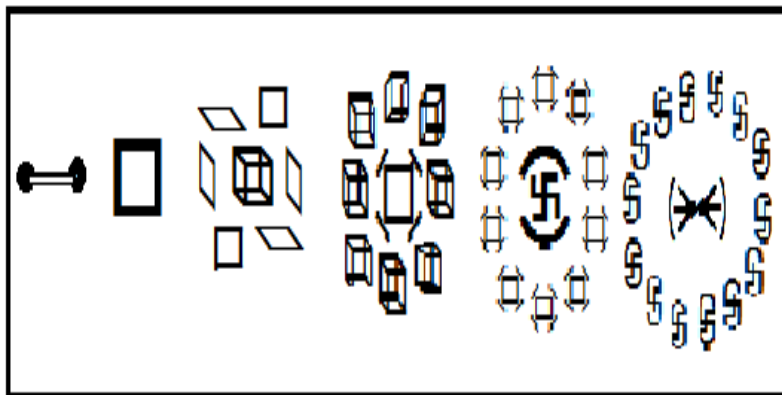

1. Sadhakas fulfilled with intensity of urge to acquire insight to attain enlightenment about vedic systems values and virtues shall urge to know the way mental states manifests and un-manifest.
2. The physical (3-space content) manifests 3-space domain and the same manifests a mental state of a linear order.
3. While one sits within a room and starts accepting the set up for the entire space existence phenomenon as of a 3-space set up, the same is because of the linear order of 3-space content which has its reach uptill the spatial boundary of 3-space domain / walls, floor and roof of the room / spatial boundary of cube / hyper cube 3.

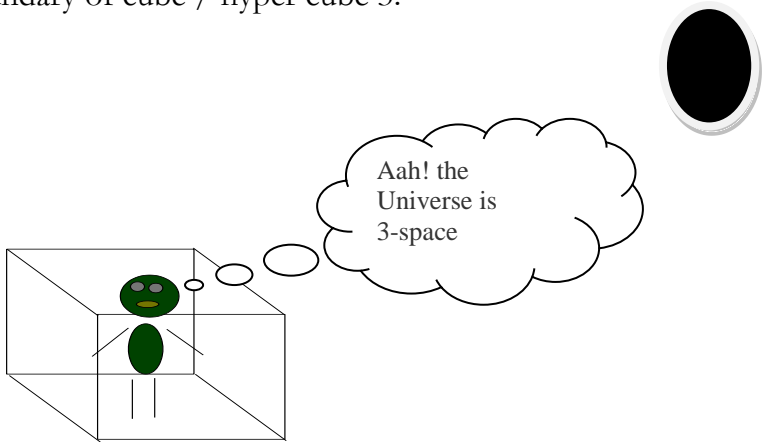

4. One may have a pause here and take note that while one comes out of a room (cube / hyper cube 3), the linear order mental state melts away and one transits from the mental state of 3-space content and mental state of 3-space melts away and same transits and re-manifest as of 4-space content

(of the spatial order of creator's space / 4-space / domain fold of hyper cube 4.

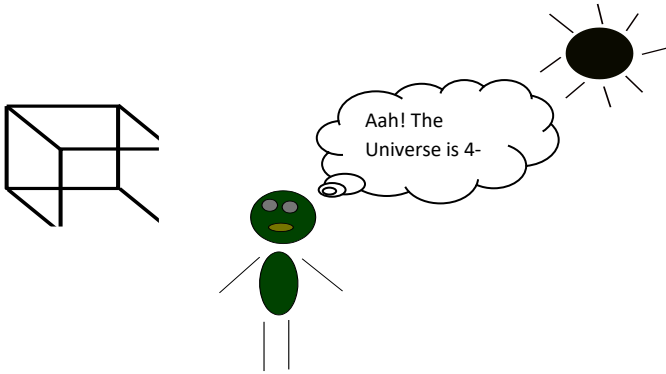

5. One may have a pause here and take note that spatial order mental state, as it is the same is because of the solid boundary of hyper cube 4.

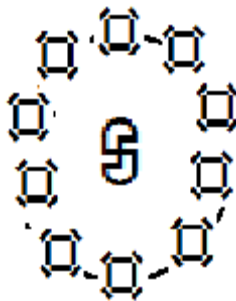

6. One may have a pause here and take note that to permit the transcending mind to glimpse and imbibe the way spatial

order mental state melts away and re-manifest as a transcendental mental state of a solid order.

7. It is going to be a transition and transformation with melting away of the solid boundary of creator's space and the same re-manifesting as a set up of transcendental content (5-space content manifesting as transcendental domain (5-space domain of hyper cube 5 enveloped with in creative boundary of ten Components

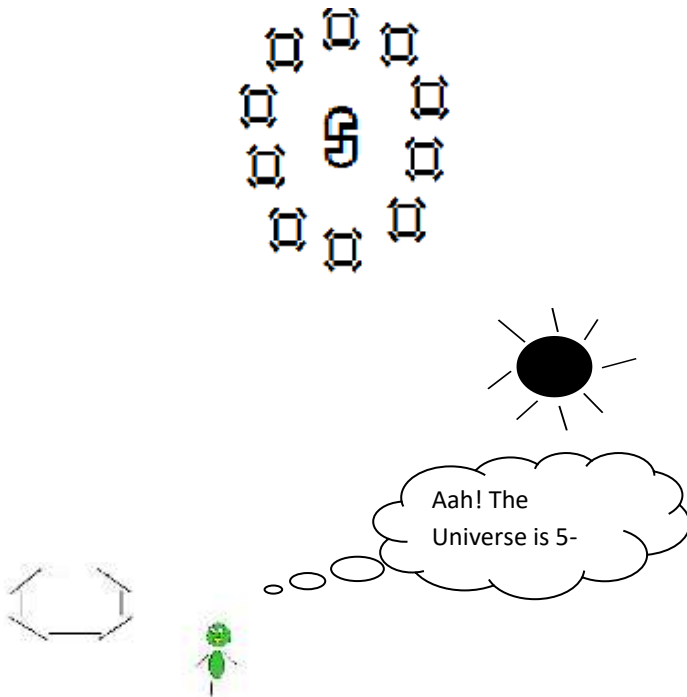

8. A step ahead, one shall permit the transcending mind to continuously remain in prolonged sitting of trans to melt away the creative boundary itself and to attain self referral mental state of the order of pursha / Sun / Vishnu Lok / 6-space self referral content manifesting as 6-space domain enveloped within transcendental boundary of 12 Components.

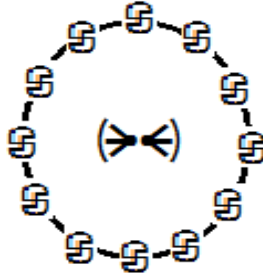

9. One may have a pause here and take note that initial linear order mental state of 3-space content (physical matter) is a mundane state / sathual Shreer manifestation / first consciousness state / jagrit avashta.
10. The spatial order mental state is manifestation of suksham shreer of swapan avashta.
11. Solid order mental state of karan shreer is the reach of sushapti avashta.
12. Creative order mental state is of karan attiet turiya avashta.
13. Beyond that is transcendental order state of truiya attiet avashta. It is unity state of existence phenomenon.

14. A step ahead, is a mental state of transcendental order set up of asht prakarti.
15. And a step ahead, is unity state order of nav Braham.
16. Even beyond that Brahman order of par Braham existence phenomenon.
17. Sadhakas fulfilled with intensity of urge to glimpse and imbibe these values and these mental states of such reach shall continuously permit the transcending mind to remain in prolonged trans and to sequentially glimpse and imbibe virtues of these values of sequential progression path of manifestation, melting of manifestation and re-manifestation process of our existence phenomenon within human frame.
18. Further, sadhakas fulfilled with intensity of urge to simultaneously follow the sankhya and yoga nishta shall also be face to face with the way sequential progression un-fold.

‘Illustrative:

As first step, one may glimpse the start with value.

As second step, one shall glimpse the next step value in relation with the first step value. Here it may not be a single value, and the same may be a pair, triple, quadruple or even bigger range of values association for the second step.

And then, in third step, one shall reach at a progression rule for the subsequent steps value that is in respect of third, fourth, fifth and subsequent step value.

19. Here, illustratively one may accept first step value ‘1’. And next step value to be ‘2’. Then one shall pause for reach at a rule for 3rd and following step value for such sequential progression reach (1, 2, ?, ?, ...).

20. One answer lead will be $(1, 1+1, 1+1+1, 1+1+1+1, \dots)$.
21. The other answer lead may be $(1, 2 \times 1, 2 \times 2 \times 1, 2 \times 2 \times 2 \times 1, \dots)$.
22. Another illustration is, as that the first step value (1) and second step value (3) will pause the similar situation of sequential progression values rule need.
23. One lead may be as $(1, 1+2 = 3, 2+3 = 5, 2+5 = 7, \dots)$.
24. The other lead would be $(1, 1+2, 1+2+3, 1+2+3+4, \dots)$.
25. Like that, reach from (a, b) would be of many fold progression expression:
(a, b, c, ...) where c may admit various different values.
26. It would be blissful to glimpse and chase:
 $(1^0, 1^1, 1^2, \dots)$
 $(0^1, 0^1, 0^2, \dots)$
 $[\{(1^1)0^1\}, \{(2^1)(1^1)\}, \dots]$
 $1, 2, 5, 12, 29, 70, \dots$
 $N, 4N-10, 25N-36, 61N-148, \dots$
27. Like that, $[\{(1, 2, 3), 7\}, \{(4, 5), 1\}, \{(6, 7), 5\}, \{(8, 9), 2\}, \dots]$
 $[\{(2 \text{ as } 1), (1 \text{ as } 3)\}, \{(3 \text{ as } 1), (1 \text{ as } 4)\}, \dots]$
28. Devnagri alphabet, Maheshwara sutras, Saraswati mantras, Gyanti mantra, ...
29. One shall sit comfortably and to permit the transcending mind to glimpse and imbibe flow of water with in pair of banks, floating solids, crystal formations, different melting points of atoms, spheres of gravitation, colour bends, rainbow, black holes, ...
30. Life death cycles, birth re-birth cycles, seed-tree-seed cycles,
31. Shad chakra coordination, dash chakra coordination

32. 10-place value system; 10^1 , 10^2 , 10^3 , 10^4 ; perfect numbers 6, 28, 496, 8128
33. Age of Brahma, age of Vishnu, age of Shiv.
34. And, like that, Sankhya Nishta and Yoga Nishta Unison formats, ...
35. Sadhakas shall sit comfortably and to permit the transcending mind to glimpse and imbibe the values and virtues of transition and transformation phenomenon of manifested state of intelligence field, consciousness state, existence phenomenon.



TRANSCENDENTAL DOMAIN

1. 5-Space content manifesting as domain fold of hyper cube 5 along format of idol of lord Brahma, over lord of real 4-space (creator space).
2. Hyper cube 5.
3. Number value 5.
4. Akash Tattav
5. Values sequence (5, 5 x 5, 5 x 5 x 5, 5 x 5 x 5 x 5), ---
6. Transcendental lord Shiv
7. Transcendence from four fold manifestation layer
8. Transcendental base of creative origin of physical world.
9. Right angle triangle (3, 4, 5, 6)
10. Quadruple values (3, 4, 5, 6)
11. Four fold manifestation layer (3, 4, 5, 6)
12. Pentagon
13. Pentagon within pentagon
14. Rik, Yajur, Sam and Athrav.
15. 21, 101, 1000, 9
16. Dimensional synthesis phenomenon
17. Domain split phenomenon
18. Jyoti manifestation
19. Divya ganga parva
20. Transcendental caur pushpika
21. Two fold transience from core of Pushpika
22. Reach from core of Pushpika orb of pushi

23. Transcendental carriers
24. Format of Sathapatyama measuring road
25. Shadechakras format
26. 120 years cyylce
27. Seed to tree - cycle
28. Jeev Atma
29. Braham
30. Par Braha
31. Sole syllable Om
32. Parnava
33. Aum
34. Aumkar
35. Udgith
36. Vshtkar
37. Pursha
38. Purshotta
39. Brahmand
40. Surya mandal
41. Yatha pinde tatha brahmnde
42. Yatha brahande
43. Self referral domain
44. Unity state natural order
45. Brahman
46. Par brahm
47. SEllf referral transcendental Par Braham

1. Places
2. Personality
3. Phases
4. Ideals
5. Books
6. Issues
7. Concerns

TRANSCENDENTAL DOMAIN

TRANSCENDENTAL BASE OF ASHTADHEY

1. Ashtadhey is organized as eight chapters of four sections each.
2. This feature, as is of value 32 (8×4), accepts re-organization as $32 = 2^5$, which is parallel to frequency of value '6' of choices from values range (1, 2, 3, 4, 5, 6).
3. Value 32 is also parallel to the range of 32 external Devtas.
4. Further, hyper cube 4 with domain boundary ratio $A^4:8 B^3$ lead to fixation of solid boundary of 8 components in terms of $8 \times 4 = 32$ coordinates in spatial dimensional frame of quadruple dimensions of creator's space within 4-space.
5. Further $32 = 14 + 18$
6. Value 14 accepts re-organization as $14 = 2 + 3 + 4 + 5$, which is parallel to four fold manifestation layer (2, 3, 4, 5) of hyper cube 4.

7. Likewise $18 = 3 + 4 + 5 + 6$ is parallel to four fold manifestation layer (3, 4, 5, 6) of hyper cube 5 the representative regular body of 5-space within 4-space.
8. One may have a pause here and take note that 5-space plays the role of origin of 4-space.
9. 5-space is origin fold of hyper cube 4 and is also of the role of 5-space as domain fold of hyper cube 5.
10. One may further have a pause here and take note that 5-space plays the role of base fold of transcendence range (1, 2, 3, 4, 5)
11. With 5-space as base of 4-space origin of 3-space, brings us face to face with organization format features of transcendental base of four fold creation of linear order set ups of hyper cube format for cube as hyper cube 3.
12. It is this feature which deserve to be comprehended well for its complete appreciation and full imbibing to acquire proper insight and to attain appropriate enlightenment about the role of transcendent base (5-space).
13. It would be blissful to take note that transcendental base (5-space) as base fold is of solid dimensional order..
14. One may have a pause here and take note that 3-space plays the role of boundary of 4-space.
15. Further 3-space content manifest as domain fold of hyper cube 3.
16. Still further 3-space plays the role of solid dimensional order 5-space base fold
17. Still further 3-space plays the role of origin of 2-space which is also having the role of spatial dimensional order of 4-space.

18. One may have a pause here and to permit the transcending mind to glimpse and imbibe the interrelated values of different roles of 2, 3, 4, 5 in their respective role in their boundary, domain, origin and base fold.
19. It would be blissful to glimpse following 5 x 5 format to have comprehensive view of interrelated roles of 1 to 9 space

1	2	3	4	5
2	3	4	5	6
3	4	5	6	7
4	5	6	7	8
5	6	7	8	9

20. It would be a blissful exercise to chase the interrelationship of 2-space with 5-space 3-space with 5-space and 4-space with 5-space.



ARTIFICES OF NUMBERS AND DIMENSIONAL FRAMES

1. Sadhakas fulfilled with intensity of urge to acquire proper insight and to attain Appropriate enlightenment about Vedic processing systems shall sit comfortably and to permit the mind to be face to face with parallel values and features and formats of artifices of numbers and dimensional frames.
2. One shall visit and revisit artifices of numbers 1 to 9 and dimensional frames of 1-space to 9-space.
3. Hyper cubes 1 to 9 are the representative regular body of 1-space to 9-space within creator's space (4-space).
4. Space content of 1-space to 9-space manifests as domain fold of respective hyper cubes.
5. Our well known body (cube) is hyper cube 3, the volume part of cube is its domain fold.
6. One may have a pause here and take note that cube / hyper cube 3 is a 4 folds manifestation layer: (1-space in the role of dimension, 2-space in the role of boundary, 3-space in the role of domain, 4-space in the role of origin).
7. For convenient reference here below is depiction and expression along 4x4 grid format of different roles to be played by a given dimensional space:

Space Body	Dimension fold	Boundary fold	Domain fold	Origin Fold
Hyper	$(N-2)$	$(N-1)$	N	$N+1$

cube (N)	Space	space	Space	Space
Hyper cube (N+1)	(N-1) Space	N space	N+1 Space	N+2 Space
Hyper cube (N+2)	N Space	N+1 Space	N+2 Space	N+3 space
Hyper cube (N+3)	N+1 Space	N+2 Space	N+3 space	N+4 Space

8. It would be blissful to reach at set ups of hyper cubes 1 to 9, as follows:

Space Body	Dimension Fold	Boundary Fold	Domain fold	Origin Fold
Hyper cube (1)	(-1) Space	(0) Space	(1) Space	(2) Space
Hyper cube (2)	(0) Space	(1) Space	(2) Space	(3) Space
Hyper cube (3)	(1) Space	(2) Space	(3) Space	(4) Space
Hyper cube (4)	(2) Space	(3) Space	(4) Space	(5) Space
Hyper cube	(3) Space	(4) Space	(5) Space	(6) space

(5)				
Hyper cube (6)	(4) Space	(5) Space	(6) space	(7) Space
Hyper cube (7)	(5) Space	(6) space	(7) Space	(8) space
Hyper cube (8)	(6) space	(7) Space	(8) space	(9) Space
Hyper cube (9)	(7) Space	(8) space	(9) Space	(10) Space

9. It would be blissful to glimpse and imbibe parallel tabulation for above roles of dimensional space as of values of artifices of numbers:

Space Body	Dimension Fold	Boundary Fold	Domain fold	Origin Fold
Hyper cube (1)	(-1)	(0)	(1)	(2)
Hyper cube (2)	(0)	(1)	(2)	(3)
Hyper cube (3)	(1)	(2)	(3)	(4)
Hyper cube	(2)	(3)	(4)	(5)

(4)				
Hyper cube (5)	(3)	(4)	(5)	(6)
Hyper cube (6)	(4)	(5)	(6)	(7)
Hyper cube (7)	(5)	(6)	(7)	(8)
Hyper cube (8)	(6)	(7)	(8)	(9)
Hyper cube (9)	(7)	(8)	(9)	(10)

10. Now one shall have a pause here and to visit the following organization along 9x9 grid of 9 rows and 9 columns:

	C1	C2	C3	C4	C5	C6	C7	C8	C9
R1	1	2	3	4	5	6	7	8	9
R2	2	3	4	5	6	7	8	9	10
R3	3	4	5	6	7	8	9	10	11
R4	4	5	6	7	8	9	10	11	12
R5	5	6	7	8	9	10	11	12	13
R6	6	7	8	9	10	11	12	13	14
R7	7	8	9	10	11	12	13	14	15
R8	8	9	10	11	12	13	14	15	16
R9	9	10	11	12	13	14	15	16	17

11. One may have a pause here and take note that hyper cube 9 is of $2 \times 9 + 1 = 19$ versions parallel to 19 geometries range of 9-space.
12. It would further be blissful to take note that $100 = 81 + 19$.
13. One shall sit comfortably and to permit the transcending mind to glimpse and imbibe these values and features.
14. It would further be blissful to take note that 9×9 grids accommodate values range 1 to 17.
15. It would further be very blissful to take note that values pair (19, 17) is parallel to the format of (19 as domain, 17 as dimension).
16. It would further be very-very blissful to take note that formulation Aatma accepts transcendental code value 17 which is parallel to 17 versions of hyper cube 8 parallel to 17 geometries of 8-space.
17. One may have a pause here and take note that the alphabet letters of devnagri alphabet accepts transcendental code value of range 1 to 16.
18. Further as that, value 16 accepts organization as $16 = 9 + 7$ and pair of values 9, 7 is of format parallel to (9-space domain, 7-space dimension).
19. It would be blissful to take note that formulation Jeev accepts transcendental code value 16.
20. Still further, $9 + 9 = 18$ is parallel to transcendental code value 18 of formulation Vidhi.
21. It would be very blissful to take note that formulation Vidhya, as well as formulations Prakarti and Ishwar as well accepts transcendental code value 18 each.

22. Still further as that, value 18 accepts organization as $18 = 3+4+5+6$, which is parallel to 4 folds manifestation layer (3, 4, 5, 6) of hyper cube 5, the representative regular body of 5-space with 4-space along the format of idol of lord Braham, over lord of creator's space (4-space).
23. Still further, it would be very blissful to take note that quadruple (3, 4, 5, 6) is parallel to organization format of right angled triangle (3, 4, 5) of area (6).
24. Still further, the feature $3^2+4^2=5^2$ bring us face to face with value $3^2+4^2+5^2 = 50$ which is parallel to 50 letters set up of devnagri alphabet of 9 vowels, 33 consonants and 8 yama letters.

Devnagri Alphabet

देवनागरी वर्णमाला

Nine vowels

अ इ उ ऋ लृ ए ओ ऐ औ

1 2 3 4 5 6 7 8 9

5 x 5 Varga consonants

क ख ग घ ङ

1 2 3 4 5

च छ ज झ ञ

2 3 4 5 6

ट ठ ड ढ ण

3 4 5 6 7

त थ द ध न

4 5 6 7 8

प फ ब भ म

5 6 7 8 9

Anthstha letters:

य र ल व

1 3 5 7

Ushmana letters:

श स ष ह

2 3 6 9

Yama letters



9 10 11 12 13 14 15 16

25. It would further be blissful to take note that number value 5 is of middle placement of values range 1, 2, 3, 4, 5, 6, 7, 8, 9. And a bend at the middle will lead to 5x5 grids, which accepts superimposition of 4x4 grids.
26. It is this feature which deserves to be comprehended well for full imbibing and complete appreciation to properly acquire insight and to appropriately attain enlightenment of transcendental code values being 1 to 16 for the 50 alphabet letter set up of Devnagri alphabet. ■

6

120 YEARS CYCLE

1. Sadhakas fulfilled with intensity of urge to acquire proper insight and to attain appropriate enlightenment about processing systems of organization formats shall glimpse and imbibe values and features of 120 years cycle.
2. Value 120 accepts re-organization as $120 = 12 \times 10$ which is parallel to 120 creative Components (4-space boundary of 10 Component of 5-space domain) envelop for the entire transcendental boundary (5-space boundary of 6-space) of self referral domain (6-space domain).
3. Life span of 120 years of existence with in human frame is chased by Jyotish Vedanga in terms of nine graham (Surya, Mangal, Ketu, Chandarma, Baraspati, Rahu, Budh, Shini and Sukar) of cycles of (6, 7, 7, 10, 16, 17, 18, 19, 20) years respectively.
4. The above values range (6, 7, 7, 10, 16, 17, 18, 19, 20), as such accepts chase as of quadruple values (6, 7, 7, 10) and of Penta values (16, 17, 18, 19, 20).
5. One may have a pause here and take note that value range (16, 17, 18, 19, 20) is of summation value $16+17+18+19+20 = '90'$.
6. And, extension of this range (16, 17, 18, 19, 20) into self referral range leads to summation value '111'.

7. One may have a pause here and have a fresh visit to value '111'.
8. The first feature of organization of '111' availing same digit '1', this and it is of virtue of having same value in between the pair of equal values.
9. This virtue is of the format of filling the gap between a pair of points with addition of a point between.
10. It is this attainment which is of value of reaching at continuity with arrangement of discrete.
11. It is this attainment which deserves to be comprehended well for its complete appreciation to imbibe it fully for proper insight acquisition and for appropriate attainment of enlightenment of the system of reaching at and working out continuity with the help of discrete values entities.
12. Further Value 111 accepts organization as $111 = 3 \times 37$.
13. Further, value 3 is parallel to synthesis value of a pair of linear dimensions: $(3 = 1, 1)$.
14. Still further value 37 is of organization $37 = 2 \times 18 + 1$, which is parallel to 37 versions of hyper cube 18 parallel to 37 geometries range of 18-space.
15. One may have a pause here and have a fresh visit to the values ranges $(16, 17, 18, 19)$, $(16, 17, 18, 19, 20)$ and $(16, 17, 18, 19, 20, 21)$.

16. It would be blissful to take note that value (16, 17, 18, 19) four folds manifestation layer (16+17+18+19) of hyper cube 18.
17. It would be blissful to take note that summation value (16+17+18+19 = 70) is parallel to domain split spectrum value at fifth step of domains: (1, 2, 5, 12, 29, 70).
18. It would be blissful to re-capitulate that $18 = (3+4+5+6)$, which is parallel to four folds manifestation layer (3, 4, 5, 6) of hyper cube 5 of representative regular body of 5-space with in 4-space along the format of idol of lord Brahma, over lord of creator's space (4-space).
19. One may further re-capitulate transcendence of the origin from within domains of hyper cubes 1 to 9 leads us to split phenomenon of values triples (1, 2, 1), (2, 3, 2), (3, 4, 3), (4, 5, 4), (5, 6, 5), (6, 7, 6), (7, 8, 7), (8, 9, 8) and so on.
20. These values triple leads us to values (121, 232, 343, 454, 565, 676, 787, 898) and so on.
21. One may have a pause here and take note that this values range is sequential increase value '111' at each step.
22. Illustratively (232-121 = 111), (343-232 = 111), and so on.
23. The quadruple values (6, 7, 7, 10) is of summation value $6+7+7+10 = 30$ which accepts organization as $30 = 6+7+8+9$, which is parallel to four folds manifestation layer (6, 7, 8, 9) of hyper cube 9.

24. It would further be blissful to take note that quadruple 6, 7, 7, 10 is a specific value of quadruple $(N, N+1, N+1, N+4)$.
25. Further as that, value 6 with its organization $6 = 0+1+2+3$ parallel to four folds manifestation layer 0, 1, 2, 3 of hyper cube 2 and value $10 = 1+2+3+4$, as four folds layer (1, 2, 3, 4) of hyper cube 3 adds to above organization as N be the summation value of hyper cube manifestation layer and its reach as $N+3$ as $N+4$ is also of next consecutive hyper cube. This way above organization is of nature and value which coordinate the pair of formats of consecutive hyper cubes.
26. One shall have a pause here and take note that the gap in between the summation layer of four folds manifestation layer of consecutive hyper cubes is bridged with the help of the boundary fold of the domain fold with summation value of first hyper cube playing the role of dimension.
27. One shall sit comfortably and to permit the transcending mind to glimpse and imbibe above values and features.
28. One may have a pause here and to permit the transcending mind to glimpse and imbibe above organization (6, 7, 7, 10) in its reverse orientation as (10, 7, 7, 6) and the same as (-10, -7, -7, -6) shall be bringing us face to face with the pair of values (-7, -7) stretching -6 as origin of -5 as -5 as domain split into a pair of dimension -7, -7.

29. One shall sit comfortably and to permit the transcending mind to glimpse and imbibe above values and features to appreciate the way Vedic systems approach manifested creation organizations.
30. It would further be blissful to take note value quadruple (6, 7, 7, 10) leads us to gaps $(7-6) = 1$, $(7-6 = 1)$, $(10-7 = 3)$, $(10-7=3)$ as of value $(1+1+3+3 = 8)$.
31. One may have a pause here and take note that value 8 is parallel to transcendental code value of formulation Chhaya.
32. Further, value (8, 9, 8) leads to summation value $(8+9+8) = 25$, which is parallel to transcendental code value 25 of formulation Sanjay. The phenomenon of Chhaya and Sanjay, both as mother of son each from Surya deserves to be comprehended well for proper appreciation and for proper insight and appropriate enlightenment about the Vedic systems of 120 years cycle. ■

NUMBER VALUE 111

1. Number value 111 is the unique feature as that it avail number value 1 for its triple places.
2. Number value 111 accepts re-organization as $111 = 3 \times 37$.
3. And, $37 = 2 \times 18 + 1$, which is parallel to 37 versions of hyper cube 18 as representative regular bodies of 37 geometries of 18-space.
4. Hyper cube 111 is a four folds manifestation layer (109, 110, 111, 112) of summation value 442.
5. Hyper cube 111 is of 223 versions.
6. One may have a pause here and take note that Ashtadhiya has 223 ganas (Groups).
7. Saravnams are 35. Visharagas are 22.
8. Origin transcendence from 1 to 8-space domain lead to values range (121, 232, 343, 454, 565, 676, 787, 898).
9. This values range leads to (120, 231, 342, 453, 564, 675, 786, 897).
10. One shall have a pause and to permit the transcending mind to glimpse through above values of triple digits with the biggest digit value at the middle placement.
11. Of these value 120 and value 786 are of transcendental features.
12. Value $222 = 111 + 111$, as such is of very rich field.
13. Sadhakas fulfilled with intensity of urge to glimpse and imbibe the values and features of vedic systems shall visit and revisit number value 111.

14. One may have a pause here and take note that number value 111 as of triple digit of equal value is of format and feature of a system of reach at continuity through discrete by inserting equal value in the gap between a pair of equal discrete value, as has been in the present case of a discrete pair of value (1, 1) and in the gap in between them standing inserting value (1) and in the process there being a reach at value (111).
15. One may have a pause here and take note that the synthesis of triple dimension of same order (N, N, N) leads to value (6), for all value of N.
16. It is this feature which deserves to be comprehended well.
17. $N = 6$, leads us to $(6, 6, 6) = (6)$.
18. One may have a pause here and take note that $(1, 1, 1) = (6)$.
19. This bring us face to face with a situation of taking '6' as one '1'.
20. It shall be bringing us face to face with a situation, which will require a revisit to our processing steps in respect of the 6-space domain set up.
21. Number value 6 is a perfect number value as $6 = 1+2+3 = 1 \times 2 \times 3 = 2 \times 3 = (-2) \times (-3)$.
22. One may have a pause here and take note that $6 = 1+2+3 = 2+2+2$.
23. Further as that, $3 = 1/1+1/1+1/1 = 2/2+2/2+2/2 = N/N+N/N+N/N$.
24. Still further within cube / hyper cube 3, manifests a cube.
25. Further also manifests interval, square and cube with in a cube.

26. One may have a pause here and take note that within corner points of a cube are manifested 3 dimensional frame of half dimension.
27. It is this phenomenon of manifestation of 3 dimensional frames of half dimensions in all the 8 corner points of cube which bring us face to face with the phenomenon of hyper cube 4, the representative regular body of 4-space accepting solid boundary of eight Components.
28. It is this phenomenon of split of a three dimensional frame into a pair of 3 dimensional frame of half dimension and re-manifestation of a pair of 3 dimensional frame of half dimension into a dimensional frame of 3 full dimensions, which deserves to be comprehended well to have proper appreciation of the existence phenomenon of 6-space domain of creative dimensional order (4-space as dimension of 6-space).
29. 6-space plays the role of origin of 5-space.
30. The transcendence of 6-space origin from 5-space domain leads to the set up 5, 6, 5 of value format 565.
31. The value $565-1 = 564 = 2 \times 282$ deserves to be comprehended well has here a middle value 8 accepts re-organization as $8 = 2^3$.
32. With it triple digit, 2, 8, 2 will leads us to organization $(2^1, 2^3, 2^1)$.
33. One may have a pause here and take note that this set up of single spatial dimension frame and triple spatial dimension frame deserves to be comprehended well for its full appreciation.

34. One may have a pause here and take note that the transcendence phenomenon of 9-space origin of 8-space domain leads us to organization (8, 9, 8).
35. One may have a pause here and take note that $8+9+8 = 25$.
36. Further as that, formulation Chhaya is of TCV value 8.
37. Formulation sanjay is of TCV value 25.
38. One shall sit comfortably and to take note that surya tej is of TCV value 28 which is parallel to TCV of formulation Braham
39. One may have a pause here and take note that formulation Nav Brahma is of TCV value $45 = 1+2+3+4+5+6+7+8+9$
40. One shall sit comfortably and to permit the transcending mind to glimpse and imbibe these values fully and to have its complete appreciation to acquire proper insight and to attain appropriate enlightenment about vedic systems and of the phenomenon of sanjay and chhaya as wives of surya and shani, the sun of chhaya and surya and shani has 19 years cyclic period in organization of 120 years cycles.
41. It would further be blissful to take note that value $19 = 2 \times 9 + 1$, which is parallel to 19 versions of hyper cube 9 as bodies of 19 geometries of 9-space.
42. It would further be blissful to take note that TCV shani is 13 which is parallel to TCV value 13 of formulation surya.
43. One shall sit comfortably and to permit the transcending mind to glimpse and imbibe these values and features to acquire proper insight and to attain appropriate enlightenment about vedic processing systems. ■

8

PANCH VIRATYA

1. Formulation Panch Varatyae is of formulation '50'
2. Value 50 as source value (origin value) takes us to hyper cube 49 as a four folds manifestation layer (47, 48, 49, 50) leading to summation value $47+48+49+50 = 194$.
3. Value 47 is the end value reach of transcendental range (2, 5, 11, 23, 47).
4. One may have a pause here and take note that this range is a range of prime values (2, 5, 11, 23 and 47), all are primes.
5. This sequential range sequentially leads us to 2-space as of 5 geometries range, 5-space as of 11 geometries range, 11-space as a 33 geometries range and 23-space as of 47 geometries range.
6. The manifestation layer (47, 48, 49, 50) accepts extension as (47, 48, 49, 50, 51) of summation value 245.
7. It also brings us face to face with the transcendence range (46, 47, 48, 49, 50) as of summation value 239.
8. One may have a pause here and take note that domain split spectrum is of sequential range of flow streams of values (1, 2, 5, 12, 29, 70, 169, ...).
9. One may have a pause here and take note that $70+169 = 239$.
10. It would further be blissful to take note that the transcending out phenomenon of origin from the 1, 2, 3, 4, 5, 6, 7, 8-space domain is of following features:
 - (i) (1, 2, 1) of summation value 4 and of the format of value 121.

- (ii) (2, 3, 2) of summation value 7 and of the format of value 232.
 - (iii) (3, 4, 3) of summation value 10 and of the format of value 343.
 - (iv) (4, 5, 4) of summation value 13 and of the format of value 454.
 - (v) (5, 6, 5) of summation value 16 and of the format of value 565.
 - (vi) (6, 7, 6) of summation value 19 and of the format of value 676.
 - (vii) (7, 8, 7) of summation value 22 and of the format of value 787.
 - (viii) (8, 9, 8) of summation value 25 and of the format of value 898.
11. One may have a pause here and to glimpse the sequential progression reach in terms of value (111).
 12. It also would be blissful to take note that the reach at the values range (120, 231, 342, 453, 564, 675, 786, 897).
 13. One may have a pause here and have a fresh visit to pair of values (120, 786).
 14. The difference value $786-120 = 666$.
 15. This difference value 666 brings us face to face with the triple self referral dimension (6-space in the role of dimension leading to synthesis value $(6, 6, 6) = (6)$).
 16. A step head, quadruple self referral dimension (6 6, 6, 6) leading to synthesis value '0' deserves to be comprehended well.

17. Sadhakas fulfilled with intensity of urge to glimpse and imbibe the values of Vedic systems shall be face to face with the following tabulation of sequential values of quadruple dimension (N, N, N, N) for all value of N, leading to the summation value for single, double, triple and quadruple dimension together as 20.

(i) $(1) = (1), (1, 1) = (3), (1, 1, 1) = (6)$ and $(1, 1, 1, 1) = (10)$.

(ii) $(2) = (2), (2, 2) = (4), (2, 2, 2) = (6)$ and $(2, 2, 2, 2) = (8)$.

(iii) $(3) = (3), (3, 3) = (5), (3, 3, 3) = (6)$ and $(3, 3, 3, 3) = (6)$.

(iv) $(4) = (4), (4, 4) = (6), (4, 4, 4) = (6)$ and $(4, 4, 4, 4) = (4)$.

(v) $(5) = (5), (5, 5) = (7), (5, 5, 5) = (6)$ and $(5, 5, 5, 5) = (2)$.

(vi) $(6) = (6), (6, 6) = (8), (6, 6, 6) = (6)$ and $(6, 6, 6, 6) = (0)$.

(vii) $(7) = (7), (7, 7) = (9), (7, 7, 7) = (6)$ and $(7, 7, 7, 7) = (-2)$.

(viii) $(8) = (7), (8, 8) = (9), (8, 8, 8) = (6)$ and $(8, 8, 8, 8) = (-2)$.

18. Sadhakas fulfilled with intensity of urge to proper insight and to attain appropriate enlightenment of above values and features of synthesis split phenomenon shall comprehend and imbibe the organization of square as quadruple quarter square. ■

QUADRUPLE PERFECT NUMBERS

(6, 28, 496, 8128)

1. Sadhakas fulfilled with intensity of urge to glimpse and imbibe organization features of Vedic (वेदिक) systems shall visit and revisit quadruple perfect numbers (6, 28, 496, 8128).
2. First feature which deserves to be appreciated for imbibing the values of quadruple perfect numbers (6, 28, 496, 8128), is that these respectively accept (3, 5, 9, 13) proper divisors.
3. Proper divisors of perfect number 6 are (1, 2, 3).
4. Proper divisors of perfect number 28 are (1, 2, 4, 7, 14).
5. Proper divisors of perfect number 496 are (1, 2, 4, 8, 16, 31, 62, 124, 248).
6. Proper divisors of perfect number 8128 are (1, 2, 4, 8, 16, 32, 64, 127, 254, 508, 1016, 2032, 4064).
7. One may have a pause here and have a fresh visit to quadruple values (3, 5, 9, 13) parallel to the number of proper divisors of quadruple perfect number (6, 28, 496, 8128).
8. Number value 3 is parallel to 3 geometries range of 1-space.
9. Number value 5 is parallel to 5 geometries range of 2-space.
10. Number value 9 is parallel to 9 geometries range of 4-space.
11. Number value 13 is parallel to 13 geometries range of 6-space.
12. One may further have a pause here and have a fresh look at quadruple values (3, 7, 31, 127), parallel to respective biggest

- prime proper factors (3, 7, 31, 127) of quadruple perfect numbers (6, 28, 496, 8128).
13. Sadhakas fulfilled with intensity of urge to acquire proper insight and to attain appropriate enlightenment about perfect numbers, shall visit and revisit first perfect number '6'.
 14. Perfect number 6 is unique, not only as that, it is the first perfect but also has sum and product of proper divisor (1, 2, 3) is equal: $(1+2+3) = (6) = (1 \times 2 \times 3)$.
 15. The second perfect number 28 with its five proper divisors (1, 2, 4, 7, 14) leads to summation value $1+2+4+7+14 = 28$ while product value $(1 \times 2 \times 4 \times 7 \times 14) = 784$ is much bigger than value 28.
 16. One may have a pause here and take note that $784 = 14 \times 28$.
 17. It would be blissful to take note that $28 = 2 \times 14$.
 18. Further, $14 = 2+3+4+5$, which is parallel to four folds manifestation layer (2, 3, 4, 5) of hyper cube 4, the representative regular body of 4-space.
 19. One may have a pause here and take note that value 6 accepts organization as $6 = 0+1+2+3$, which is parallel to four folds manifestation layer (0, 1, 2, 3) of hyper cube 2.
 20. One may have a pause here and take note that $14+28 = 42$, which accepts organization as $[(2+3+4+5+6) + (2) + (2+3+4+5+6) = 42$, which is parallel to synthesis value of a pair of transcendence range of spatial order.
 21. Value 42 also as a dimensional fold lead us to quadruple manifestation layer (42, 43, 44, 45) as a four folds manifestation layer of hyper cube 44.

22. It would further be blissful to take note that summation value $(42+43+44+45) = 174 = 2 \times 87 = 6 \times 29$, with number value 29 being parallel to TCV value of formulation Brahma, over Lord of real 4-space with hyper cube 4, the representative regular body of 4-space, being of format feature parallel to the format feature of idol of lord Brahma.
23. One may further have a pause here and take note that value 45 is of organization $45 = 1+2+3+4+5+6+7+8+9$ and it is also parallel to transcendental code value 45 of formulation Nav Braham.
24. Perfect number 496 accepts 9 proper divisors (1, 2, 4, 8, 16, 31, 62, 124, 248).
25. It would be blissful to take note that values triple (3, 5, 9) parallel to respective number of proper divisors (3, 5, 9) of perfect numbers (6, 28, 496) brings us face to face with the feature as that, number value 5 is of middle placement of values range (1, 2, 3, 4, 5, 6, 7, 8, 9), while number value 3 is of middle placement of values range (1, 2, 4, 5).
26. One may have a pause here and take note that ten place value system is of nine numerals range while 6 place value systems is of 5 numerals range.
27. And, 4 place value systems is of 3 numerals range.
28. It also would be blissful to take note that 4-space plays the role of dimension of 6-space, and further, $1+2+3+4 = 10$.
29. The values equations $(1+2+3+4) = 10$ is parallel to synthetic set up of Sathapatya measuring rod of hyper cubes 1, 2, 3, 4 of 4-space.

30. One may have a pause here and to permit the transcending mind to glimpse 4-space domain within 4-space domain.
31. Further, 4-space as creative boundary of transcendental domain (5-space is of ten components).
32. One shall sit comfortably and to permit the transcending mind to glimpse and imbibe these values and features.
33. One shall fully glimpse and imbibe these features for their complete appreciation to proper insight and to attain appropriate enlightenment about organization features of first triple perfect number (6, 28, 496).
34. One shall further sit comfortably and to permit the transcending to be in a prolonged trans state to further transcend to glimpse number value 6 as Surya Ank (सुर्या अंक) (number of Sun)(सुर्य).
35. One may have a pause here and take note that formulation surya (सुर्या) is of transcendental code value 13 which is parallel to 13 geometries range of 6-space which accepts respective 13 versions of hyper cube 6 as their representative regular bodies.
36. It would be blissful to take note that four perfect number 8128 accepts 13 proper divisors: (1, 2, 4, 8, 16, 32, 64, 127, 254, 508, 1016, 2032, 4064).
37. To have an idea as to the sequential increase in respect of product of proper divisor of perfect number (6, 28, 486, 8128) one shall reach at these products being of values:
 (i)($1 \times 2 \times 3 = 6$), (ii) $1 \times 2 \times 4 \times 7 \times 14 = 784$, (iii)
 $1 \times 2 \times 4 \times 8 \times 16 \times 31 \times 62 \times 124 \times 248 = 60523872256$.

38. The product of 13 proper divisors of 4th perfect number 8128 is :

(i) 1

(ii) $1 \times 2 = 2$,

(iii) $1 \times 2 \times 4 = 8$

(iv) $1 \times 2 \times 4 \times 8 = 64$

(v) $1 \times 2 \times 4 \times 8 \times 16 = 1024$

(vi) $1 \times 2 \times 4 \times 8 \times 16 \times 32 = 32768$

(vii) $1 \times 2 \times 4 \times 8 \times 16 \times 32 \times 64 = 2097152$

(viii) $2097152 \times 127 = 266338304$

(ix) $266338304 \times 254 = 67649929216$

(x) $67649929216 \times 508 = 34366164041728$

(xi) $34366164041728 \times 1016 = 34916024698395648$

(xii) $34916024698395648 \times 2032 = 70949362187149946726$
=S

(xiii) $S \times 4064 = S \times 4 \times 1000 + S \times 6 \times 10 + S \times 4$

(a) $4S = 4x$

(b) $6S = 6x$

(c) $4S \times 1000 =$

(d) $6S \times 10 =$

39. One may have a pause here and take note that product of proper divisor of first quadruple perfect number are of (1, 3, 11, 24) digits numbers values.

40. One may have a pause here and to permit the transcending mind to continuously remain in trans and to glimpse and imbibe the values range of numbers of digits (1, 3, 11, 24) and to acquire insight as to the comprehension coverage range of Vedic Systems.

41. It would be blissful to take note that value 1 as number 1 is of transcendental code value 8.
42. Value 3 as formulation Triya (तृय) as well is of transcendental code value 8.
43. Formulation Asht (अष्ट) is of transcendental code value 11.
44. Number value 24 is of organization $24 = 11+13$.
45. Number values pair (11, 13) is of the format of (11 as dimension, 13 as domain).
46. Number value 11 is parallel to 11 geometries range of 5-space.
47. Number value 13 is parallel to 13 geometries range of 6-space.
48. One may have a pause here and take note that 4-space as dimension of 6-space and (-6-space) as dimension of (-4-space), leads to 11 steps long coverage range (-46, -35, -24, -13, -2, 9, 20, 31, 42, 53, 64).
49. One may have a pause here and take note that the above values range -46 to 64 is the synthesis value range of synthesis values of pair of transcendence range of orders (-6, -5, -4, -3, -2, -1, 0, 1, 2, 3, 4).
50. One shall sit comfortably and to permit the transcending mind to glimpse and imbibe above values and features.
51. It would be blissful to permit the transcending mind to continuously glimpse the prolonged sitting of trans and to glimpse the transcendental range of 5 perfect numbers and to be on the virtues transcendental format of Vedic systems chase of our existence phenomenon of solar universe.

52. Vedic systems sequentially chase existence phenomenon by firstly approaching sun in-terms of number value 6 and reaching at the chase in terms of number value 13.
53. The sequential chase ahead, is in terms of values range (16, 17, 18, 19, 20, 21) as a first phase and as 21, 22, 23, 24, 25, 26 as a second phase.
54. Sadhakas fulfilled with intensity of urge to be parallel with processing steps of Vedic systems shall glimpse and imbibe the values and features of following formulations:
- (i) Jeev (जीव) accepting transcendental code value 16.
 - (ii) Aatma (आत्मा) accepting transcendental code value 17.
 - (iii) Ishwar (ईश्वर) accepting transcendental code value 18.
 - (iv) Savita (सविता) accepting transcendental code value 19.
 - (v) Dev (देव) accepting transcendental code value 20.
 - (vi) Gyan (ज्ञान) accepting transcendental code value 21.
 - (vii) Samriti (स्मृति) accepting transcendental code value 22.
 - (viii) Annant (अन्नत) accepting transcendental code value 23.
 - (ix) Pursha (पुरुष) accepting transcendental code value 24.
 - (x) Vishnu (विष्णु) accepting transcendental code value 25.
 - (xi) Turyia (तुरीया) accepting transcendental code value 16 and formulation Sodash (षोडश) accepting transcendental code value 26.
 - (xii) Value 26 with organization $26 = 19+7$, being parallel to transcendental code value $19+7$ of formulation Savita Kariya (सविता कार्य) of Suksham (सूक्ष्म).

- (xiii) A reach from Sthul (स्थूल) (TCV 20) to Suksham (सूक्ष्म) (TCV 26) is the reach step on Vedic format to Brahman.
55. Formulation Ved (वेद) is of transcendental code value (20).
56. Formulation Brahman is of transcendental code value 37 which is parallel to 37 geometries range of 18-space and there are 37 versions of hyper cube 18, the representative regular body of 18-space.
57. One shall sit comfortably and to permit the transcending mind to glimpse and imbibe the format of values pair (18, 20) parallel to 18-space as dimension, 20-space as domain.
58. It will be blissful to permit the transcending mind to glimpse and imbibe transcendental code value 18 of formulation Ishwar (ईश्वर) and transcendental code value 37 as transcendental code value of formulation Sri Bhagwan.



**VEDIC MATHEMATICS FORMAT
AND
FORMAT OF MODERN MATHEMATICS**

CONTENTS

8. Vedic Mathematics format & format of modern mathematics	1-5
9. Bindu Sarovar	6-15
10. Ardh Matra	16-24
11. Tri-Pundarm	25-30
12. Swastik Pada	31-34
13. Word Formulation Pinda	35-43
14. Devnagri Alphabet with TCV value	44-45

VEDIC MATHEMATICS FORMAT AND FORMAT OF MODERN MATHEMATICS

VEDIC MATHEMATICS FORMAT

1. Vedic Mathematics format is of features and values settling the organization format of Vedas.
2. Following 32 scripture will help acquire proper insight and to attain appropriate enlightenment about Vedic Mathematics format.

(i) Rig Ved ऋग्वेद (ii) Yajur Ved यजुर्वेद (iii) Sama Ved समवेद (iv) Atharv Ved अथर्ववेद (v) Ayur upved आयुर्वेद (vi) Dhanur upved धनुर्वेद (vii) Gandharv upved गन्धर्व वेद (viii) Sthapatya upved स्थापत्य वेद (ix) Shiksha शिक्षा (x) Vyakaran व्याकरण (xi) Nirukt निरुक्त (Xii) Chandas छन्दस् (Xiii) Jyotish ज्योतिष् (xiv) Kalpa कल्प (Xv) Sankhya darshan सांख्यदर्शन (xvi) Yoga darshan योगदर्शन (Xvii) Nayaya darshan न्याय दर्शन (xviii) Vaiesheshik darshan वैशेषिकदर्शन (Xix) Purv Mimansa darshan पूर्वमीमांसादर्शन (xx) Brahmsutar / uttar mimansa darshan / vedanta ब्रह्मसूत्र / उत्तरमीमांसादर्शन वेदान्त (XXi) Isha Upnashids ईशः उपनिषदः (XXii) Mandakyo माण्डूक्योपनिषद् (XXiii) Mundakyo मुण्डकोपनिषद् (XXiv) Kena केने उपनिषदः (XXv) Katho कठो उपनिषदः (XXvi) Parshno प्रश्नोपनिषदः (XXvii) Taitettaryo तैत्तरीयोपनिषद् (XXviii) Aeitettariyo ऐतरीयोपनिषद् (XXix)

Swatashwro श्वतेश्वरोपनिषदः (Xxx) Chandagayo
 छन्दोग्योपनिषद् (Xxxi) Brehdaryanka बृहदराण्यका उपनिषदः
 (Xxxii) Sri mad Bhagwad Geeta गीता

3. In addition the Vedic literature (scripture accepting Vedas as source) also will lead to dipper insight about the features and values basis of Vedic Mathematics.
4. One shall sit comfortably and to permit the transcending mind to glimpse and imbibe these values and features and one shall be faced to face with spatial order creator's space with transcendental origin manifesting Vedic Mathematics format.
5. Spatial order itself of zero order and with it Vedic Mathematics format leads to 0-space in the role of dimension of dimension of creator's space (4-space) with transcendental origin (5-space of solid order as origin of creator's space of spatial order).

FORMAT OF MODERN MATHEMATICS

6. Format of modern mathematics is of values and features at the base of the mathematical problems raised and answered during 20th century and continued to be ranged and answered accepting the same values and features.
7. One shall sit comfortably and to permit the transcending mind to glimpse and imbibe these features by being face to face with Hilbert's enlistment of problems in 1900.
8. The problems solved since 1995, the year of proof of Fermat's last theorem, till proof of pentagonal tiling (in 2015),

and till date will help us comprehend as that it is all about taming of surface curve.

9. Modern mind is struggling tame surface curve and is at every step getting blocked with the linearity order and transition there from and transformation in the form of spatial order is eluding comprehensive acceptance on the part of modern mathematical mind is there not only because of the Axioms and postulate but also is because of repulsive response of transcendence at the origin and consciously compatification of whole range of origins of higher dimensional spaces.

0-ORDER OF SPATIAL SPACE

10. Conceptually Vedic systems work with basic constituent of structure being Bindu, a structure point.
11. Word formulation Bindu is of transcendental code value '26'.
12. Value 26 accepts re-organization as $26 = 5+6+7+8$, which is parallel to hyper cube 7, representative regular body of 7-space unity space of transcendental order (5-space in the role of 7-space).
13. One may have a pause here and take note that the operation $[\{(N+(N+2)) + \{N \times (N+2)\} + \{2(N+2)+1\})]$ for odd values of N accept organization as $(M+(M+1)+(M+2)+(M+3))$ parallel to four folds manifestation layers (M, M+1, M+2, M+3) of hyper cube (M+2) with $M = N+4$.
14. One may have a pause here and take note that (N, N+2, N+4) as such is the format of N-space as dimension of (N+2-space and (N+2-space) being dimension of N+4-space.

15. One may further have a pause here and take that this amounts shift from dimension of dimension (N-space) to (N+4) domain.
16. It would be blissful to revisit above for $N = 3$.
17. $(3+5)+(3 \times 5)+(2 \times 5+1) = 34$.
18. Value 34 accepts organization as $34 = 7+8+9+10$, parallel to four folds manifestation layer (7, 8, 9, 10) of hyper cube 9 with 7-space in the role of dimension of 9-space.
19. One shall have a pause here and to permit the transcending mind to glimpse and imbibe the above reach of Vedic mathematics.

-84	-50	-24	-6	4	6	-6	-4	6	24	50	84
-75	-45	-22	-6	3	5	-5	-3	6	22	45	75
-66	-40	-20	-6	2	4	-4	-2	6	20	40	66
-57	-35	-18	-6	1	3	-3	-1	6	18	35	57
-48	-30	-16	-6	0	2	-2	0	6	16	30	48
-39	-25	-14	-6	-1	1	-1	1	6	14	25	39
-30	-20	-12	-6	-2	0	0	2	6	12	20	30
-21	-15	-10	-6	-3	-1	1	3	6	10	15	21
-12	-10	-8	-6	-4	-2	2	4	6	8	10	12
-3	-5	-6	-6	-5	-3	3	5	6	6	5	3
6	0	-4	-6	-6	-4	4	6	6	4	0	-6
15	5	-2	-6	-7	-5	5	7	6	2	-5	-15
24	10	0	-6	-8	-6	6	8	6	0	-10	-24
33	15	2	-6	-9	-7	7	9	6	-2	-15	-33

20. Vedic Mathematics comprehension and imbibing of the features and values of the format of 0-space in the role of

dimension of 2-space has helped to reach at dimensional synthesis values for whole range of dimensional spaces for every number of dimension of same order, being of following tabulation:

MELTING OF MENTAL STATE

21. Modern mathematical mind is of linear order while Vedic mathematical mind is of spatial order mind, as such transition and transformation and for parallel chase format there is a need for melting of mental state of linear order for transition and transformation into as of mental state of spatial order.
22. With this transition and transformation the whole chase would shift from the space within a three dimensional frame of 3 linear dimension into a space within a dimensional frame of quadruple spatial dimension.
23. Sequentially, the transition would proceed ahead, firstly from space within a three dimensional frame of 3 linear dimensions into space within a dimensional frame of quadruple spatial dimensions, and at next step into a space within dimensional frame of Penta solid dimensions.
24. One shall sit comfortably and to permit the transcending mind to glimpse and imbibe these values and features of Vedic Mathematics format vis-à-vis format of modern mathematics.



VEDIC MATHEMATICS FORMAT AND FORMAT OF MODERN MATHEMATICS

(बिन्दु सरोवर) (BINDU SAROVAR)

1. Sadhakas fulfilled with intensity of urge to glimpse and imbibe the values and features of chase format of Vedic Mathematics shall sit comfortably and to permit the transcending mind to glimpse and imbibe word formulation (बिन्दु सरोवर) (BINDU SAROVAR).
2. Formulation (बिन्दु) Bindu is of transcendental code value '26'.
3. Formulation (बिन्दु) Bindu is a composition of pair of syllables (i) (बि) TCV 9), and (ii) (न्दु) TCV 17).
4. One may have a pause here and take note that value 26 with organization $26 = 9+17 = 9+8+9$, with its reversal orientations (-9, -8, -9) brings us face to face with the organization of (-9-space domain) with origin (-8-space) leads to origin transcendence spectrum (-9, -8, -9).
5. One may have a pause here and take note that formulation (बि) is of transcendental code value 9 with organization $9 = 7+2$ and formulation (दु) as well is of transcendental code value 9 but of organization $9 = 6+3$.
6. One may further have a pause here and take note that composition of formulation (बि) = $9 = 7+2$ is parallel to the

format of divya ganga flow from first Component (बिन्दु सरोवर) (BINDU SAROVAR) of sole syllable Om, as seven streams reaching uptill second Component (अर्धमात्रा) Ardh Matra.

7. Further, formulation (३) of TCV value 9 of organization $9 = 6+3$ is parallel to the format of split of seven streams as a pair of 3 streams towards east and 3 streams towards west and the central streams proceeding ahead for its reach within the pushpika.
8. One may have a pause here and take note that above split is parallel to a split of a three dimensional frames into a pair of three dimensional frames of half dimensions of opposite orientations.
9. One may further have a pause here and take note that devnagri script of values pairs (३, ६) is of opposite orientation.
10. This feature deserves to be comprehended well for its complete comprehension and full appreciation as parallel to it is the composition of organization of formulation (३) of transcendental code value 9 with organization $9 = 6+3$.
11. One may further have a pause here and take note that the central stream as of its reach with in pushpika, further brings us face to face with word formulation (एक) of transcendental code value (8) parallel to TCV (८) = 8.
12. One may have a pause here and take note that pushpika is of the format of hyper cube 4, the representative regular body of

- 4-space as four space domain enveloped within solid boundary of 8 Components.
13. One may further have a pause here and take note that 4-space is of transcendental origin (5-space as origin) and that 5-space is of a solid order and this as such brings us face to face with the reach of central stream within pushpika making a set up of transcendental domain superimposed with solid order, as a set up and composition $8 = 5+3$.
 14. One shall sit comfortably and to permit the transcending mind to continuously remain in prolonged sitting of trans and to glimpse and imbibe these features and values of composition organization of word formulation (बिन्दु).
 15. Vedic systems approach structure of (बिन्दु) as (सरोवर) / Sarovar / Reservoir.
 16. One may have a pause here and take note that word formulations (बिन्दु) as well as (सरोवर) both accepts transcendental code value 26 each.
 17. Word formulation (सरोवर) is a composition of quadruple syllables (i) (स) of transcendental code value 4, (ii) (रो) of transcendental code value '10', (iii) (व) of transcendental code value '8', (iv) (र) of transcendental code value '4'.
 18. The first syllable (स) of transcendental code value 4 is of organization $4 = 3+1$.
 19. One may have a pause here and take note that values pair (3, 1) is of the format of 3-space domain with 1-space in the role of dimension.

20. Second syllable (रो) is of transcendental code value $10 = 3+7$.
21. One may have a pause here and take note that values pair (3, 7) is parallel to 3-space being of 7 geometries range and parallel to it cube / hyper cube 3 is of 7 versions parallel to representative regular body of 7 geometries of 3-space.
22. Third syllable () is of transcendental code value $8 = 7+1$.
23. One may have a pause here and take note that values pair (7, 1) is parallel to the reach of linear order (1-space in the role of dimension) is uptill 7 progressive steps only.
24. One may have a pause here and take note that hyper circles 1 to 7 increase and from hyper circle 8 onwards there is decrease and this as such makes the reach uptill hyper circle 7 as the upper limit of the linear order reach.
25. Fourth syllable (र) as well is of transcendental code value $4 = 3+1$.
26. One may have a pause here and take note that first and fourth syllables are of transcendental code value four each.
27. The reach from first syllable to the second syllable is reach from value (4 to value 10).
28. One may have a pause here and take note that value pairs (4, 10), is of the format of a reach for 4-space domain uptill creative boundary of ten Components of transcendental domain (4-space as boundary of 10 Component of 5-space domain).
29. Further values pair (4, 10) brings us face to face with $4 = 1+1+1+1$ and $10 = 1+2+3+4$, a pair of affine equal values

- progression (1, 1, 1, 1) and sequential values progression (1, 2, 3, 4).
30. The reach from 4th syllable to 3rd syllable is a reach of values pair (4, 8).
 31. One may have a pause here and take note that values pair (4, 8) is parallel to the format of 4-space domain accepting solid boundary of 8 Components.
 32. Further, 4-space plays the role of origin of 3-space and because of spatial order of 4-space, 3-space splits into eight octants and parallel to it there happens to be a split of cube into sub cubes.
 33. Further, this leads to the internal organization of the volume of cube in-terms of its four internal diagonal coordinating all the eight corner points of the cube.
 34. It further, bring face to face with the set up of 3 dimensional frames of half dimensions imbedded in each of the 8 corner points of the cube.
 35. One shall sit comfortably and to permit the transcending mind to glimpse and imbibe these values and features of composition of formulation (सरोवर) of TCV values range (3, 1, 3, 7, 7, 1, 3, 1).
 36. Inward progression from both ends, as such, here of this range is of opposite orientation as much as that the pair of initial step from one end are of values pair (3, 1) while the same from the other end is of values pair (1, 3).
 37. A step ahead, the progression from the first end is of values triple (3, 1, 7) while from the other end is of values triple (1, 3, 1).

38. One shall sit comfortably and to permit the transcending mind to continuously remain in prolonged sitting of trans and to glimpse and imbibe the values and features of progression format from the first end beginning with value 3 and sequentially reach at values (3, 1), (3, 1, 7), (3, 1, 7, 7).
39. Then, to chase inward progression from the other end as of values steps (1), (1, 3), (1, 3, 3), (1, 3, 1, 7).
40. It would further be a blissful exercise to chase above organization format as of quadruple syllable transcendental code values (4, 10, 8, 4) by plotting them along the circumference for having insight about the internal organization of the syllables themselves:

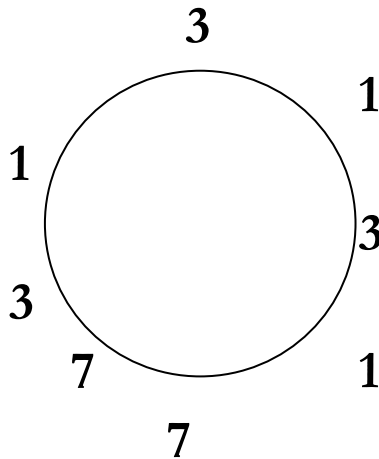

41. One may have a pause here and take note that at fourth step form either ends the reach is at value (7).

42. Pair of values (7, 7) as middle value (14), deserves to be revisited in the light word formulation (Sapt) (सप्त) which is of simple rendering as value (7) while it is of transcendental code value (14).
43. A step ahead, from the middle values pair (7, 7) will sequentially lead us to triple values pairs (3, 1), (1, 3) and (3, 1).
44. One may have a pause here and take note that triple pairs (3, 1), (1, 3), (3, 1) brings us face to face with the double reflection pairing organization, with first phase as of a reach (3, 1) to (1, 3) and at second phase the reach being from (1, 3) to (3, 1), the original position.
45. One shall sit comfortably and to permit the transcending mind to continuously remain in prolonged sitting of trans and fully glimpse above organization feature and values of composition organization format of formulation (सरोवर)..
46. Further one shall revisit quadruple pairs values features:
(i) (7, 7), (ii) 3, 1, (iii) 1, 3, (iv) 3, 1,
47. For their composite value quadruple (14, 4, 4, 4), and also for their first digits (7, 3, 1, 7) and (7, 1, 3, 1).
48. Still further, the chase also shall be for both orientations:
(14, 4, 4, 4) and for (4, 4, 4, 14).
49. Further, as the linear order structure 3-space domain, and a head 4-space domain becomes a domain of spatial order, and as such (4, 4, 4, as first three steps, and (14) being the fourth step, will help us comprehend and to appreciate the re-organization of value $14 = 2+3+4+5$ which is parallel to four

- folds manifestation layer 2, 3, 4, 5 of hyper cube 4, the representative regular body of spatial order 4-space.
50. Further as that $2+2 = 4 = 2 \times 2 = (-2) \times (-2)$ as such not only the addition and multiplication operation get superimposed in distinguishably but also same become the fait of pair of opposite orientation as well..
 51. One may have a pause here and take note that it is because of these features that while linear order mathematics of 3-space permit working in terms of '1' as 1 but the spatial order of 4-space permits working, firstly as '2 as 1 and secondly (1 as 2.
 52. One shall sit comfortably and to permit the transcending mind to continuously remain in prolonged sitting of trans and to glimpse formulation (Sapt), firstly for its simple rending value 7 and then also for its transcendental code value (14).
 53. Sadhakas fulfilled with intensity of urge to fully glimpse and completely imbibe the working steps of Vedic Mathematics of spatial order shall permit the transcending mind to glimpse and imbibe the transcendental origin (5-space as origin) of solid order of spatial order creative space (4-space) with 2-space as dimension.
 54. Creator's space (4-space) being of spatial order, same permits progression along a pair of streams, and likewise the transcendental space (5-space) because of its solid order permit progression as triple streams.
 55. One shall permit the transcending mind to glimpse and imbibe the following progression, at the fifth step for four folds manifestation layers (2, 3, 4, 5) of summation value 14.

- (i) (2, 3, 4, 5) of reach (2, 3, 4, 5, 6) as a linear progression.
- (ii) (2, 3, 4, 5) as (2, 3, 4, 5, 5) as spatial progression.
- (iii) (2, 3, 4, 5) as [$\{2, 3, 4, 5\}$, (2, 3, 4, 5), (2, 3, 4, 5)]
56. One may have a pause here and take note that (2, 3, 4, 5, 6) is of summation value $20 = 14+6$.
57. Further 2, 3, 4, 5, 5 is of summation value $19 = 14+5$.
58. Still further, [$\{2, 3, 4, 5\}$, (2, 3, 4, 5), (2, 3, 4, 5)] is of summation value $42 = 14+28$.
59. One may have a pause here and take note that value (6) is the first perfect number value.
60. Further value 28 is the second perfect number value.
61. Value 6 is of 3 proper divisors, while value 28 is of 5 proper divisors and values pair (3, 5) is of format of 3-space as dimension and 5-space as domain.
62. It will be blissful to take note that value 20 is parallel to transcendental code value of formulation (वेद), as well of (देव).
63. And, value 19 is parallel to transcendental code value 19 of formulation (सविता) as well as of (कृष्ण)
64. And, value 42 is parallel to transcendental code value 42 of formulation (तत्त्वज्ञान).
65. Vedic systems reach is the reach of (क्षेत्रं क्षेत्रज्ञ तत्त्वज्ञान), the essence of values and virtues of existence phenomenon.
66. It would be blissful exercise to fully glimpse and imbibe the values and features of formulations (क्षेत्रं क्षेत्रज्ञ तत्त्वज्ञान).

67. Formulation (क्षेत्रं) is of transcendental code value 20 which is parallel to synthesis value of a pair of transcendence range of zero order: $(0+1+2+3+4)+(0)+(0+1+2+3+4) = 20$.
68. Formulation (क्षेत्रज्ञ) is of transcendental code value 31, which is parallel to synthesis value of a pair of transcendence range of linear order $(1+2+3+4+5)+(1)+(1+2+3+4+5) = 31$.
69. Formulation (तत्त्वज्ञान) is of transcendental code value 42 which is parallel to synthesis value of a pair of transcendence ranges of spatial order: $(2+3+4+5+6)+(2)+(2+3+4+5+6) = 42$.
70. One may have a pause here and take note that value 42 accepts organization as $42 = 21+21$ and value 21 accepts organization as $21 = 1+2+3+4+5+6$ which is parallel to self referral (1, 2, 3, 4, 5, 6) of the format and features of Sathapatya measuring rod synthesized by hyper cubes 1 to 6 of values and virtues of format of swapping of self referral domain of Surya (Sun), a real 6-space body.
71. One shall sit comfortably and to permit the transcending mind to continuously remain in prolonged sitting trans and to glimpse and imbibe the above values and features of Vedic systems attainment of the order of (क्षेत्रं क्षेत्रज्ञ तत्त्वज्ञान).



VEDIC MATHEMATICS FORMAT AND FORMAT OF MODERN MATHEMATICS

(अर्धमात्रा) (ARDH MATRA)

(ॐ इत्येकाक्षरं ब्रह्म)

SOLE SYLLABLE OM

(बिन्दु सरोवर)		Bindu- Sarovar
(अर्धमात्रा)		Ardh Matra
(त्रिपुण्ड्र)		Tri-Pundram
(स्वास्तिक पाद)		Swastik Pada
(सनातन)		Sanatana

1. Sadhakas fulfilled with intensity of urge to acquire proper insight and to attain appropriate enlightenment of vedic systems shall permit the transcending mind to continuously remain in prolonged sitting of trans and to glimpse and imbibe the values and features, as well as the organization

format of Enlightenment: (ॐ इत्येकाक्षरं ब्रह्म) (Om Iti Ek Akshar Braham) / Sole Brahman Syllable Om.

2. Along artifices of quadruple Components [बिन्दु सरोवर (Bindu Sarovar), अर्धमात्रा (Ardh Matra), त्रिपुण्ड्र (Tri-Pundram) and स्वास्तिक पाद (Swastik Pada)] of sole syllable Om flow Divya-Ganga flow and attains its reach in Brahman domain.
3. Sadhakas fulfilled with intensity of urge to glimpse and imbibe the sequential flow steps of Divya-ganga along sole syllable Om shall be face to face with the transcendental code values of formulation [बिन्दु सरोवर (Bindu Sarovar), अर्धमात्रा (Ardh Matra), त्रिपुण्ड्र (Tri-Pundram) and स्वास्तिक पाद (Swastik Pada)]:
 - (i) TCV (बिन्दु सरोवर) = 52
 - (ii) TCV (अर्धमात्रा) = 29
 - (iii) TCV (त्रिपुण्ड्र) = 51
 - (iv) TCV (स्वास्तिक पाद) = 37
4. It would further be blissful to take note that TCV (सनातन) = 28 is parallel to TCV (ब्रह्म) = 28.
5. One may have a pause here and take note that value 52 with its organization $52 = 13 \times 4$, is parallel to 13 creative dimensions (4-space as dimension of 6-space with 13 geometries range) and with it one come face to face with Bindu Sarovar (बिन्दु सरोवर), a point reservoir being fulfilled with parallel structure of 6-space domain.

6. One may further have a pause here and take note that value 6 is the value of first perfect number (6) while value 28 is the value of second perfect number (28).
7. One shall sit comfortably and to permit the transcending mind to glimpse and imbibe to flow format of Divya-ganga flow as of reach from first perfect number (6) to second perfect number (28).

ARDH MATRA (अर्धमात्रा)

8. Formulation (अर्धमात्रा) is of transcendental code value 29.

(अर्धमात्रा)

$$(1+2+7+1+9+2+4+1+2 = 29)$$

अ	८	ध्	अ	म्	आ	त्	८	आ
1	2	7	1	9	2	4	1	2

9. Value 29 is parallel to domain split spectrum at its fourth phase split:

$$(1, 2, 5, 12, \mathbf{29}, 70, 169, 408, 985, \dots)$$

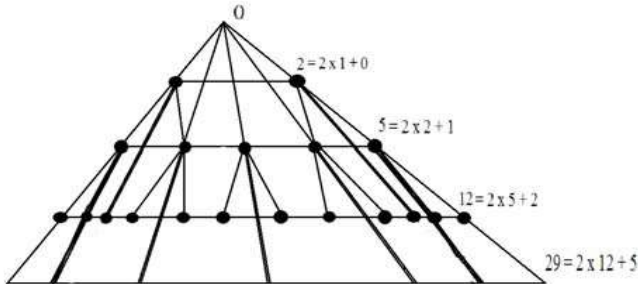

10. Further, value 29 accepts organization as $29 = 15+14$, parallel to the set up of 15 points along with their 14 gaps.
11. One may have a pause here and take note that formulation (स्वर) (vowel) is of transcendental code value 15 while the formulation (व्यञ्जन) (Consonant) is of transcendental code value (29).
12. One shall sit comfortably and to permit the transcending mind to continuously remain in prolonged sitting of trans and to glimpse and imbibe value 29 as transcendental code value of Ardh Matra, as well as of Vyanjan.
13. Further as that, value 29 is the value of domain split at 4th phase.
14. Still further, as that, Sama Ved samhita is a scripture of 29 Archiks.
15. Fifth chapter of Srimad Bhagwad Geeta is of 29 Shalokas range.
16. Srimad Durga Sapt Sati is a scripture with its last (13th) chapter being of the range of 29 Shalokas / Ardh Shalokas / Uvachas, all together.
17. One shall sit comfortably and to continuously remain in prolonged sitting of trans to glimpse and imbibe these values and features.
18. One may further have a pause here and take note that value 29 accepts organization: $29 = 2 \times 14 + 1$, which is parallel to 29 versions of hyper cube 14 as a four folds manifestation layers (12, 13, 14, 15) of summation value $12+13+14+15 = 54$

which accepts (domain, dimension format with value (52) as TCV of formulation Bindu Sarovar (बिन्दु सरोवर).

19. One may have a pause here and take note that value 14 accepts organization as $14 = 2+3+4+5$, which is parallel to four folds manifestation layers 2, 3, 4, 5 of hyper cube 4, the representative regular body of creator's space (4-space).

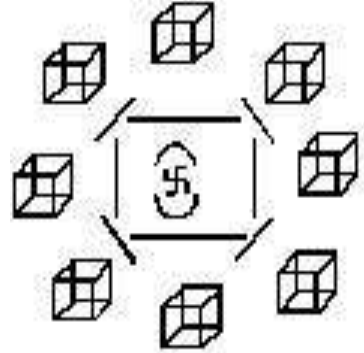

20. It would be blissful to take note that lord Brahma, four head lord, with a pair of eyes in each head, and of lotus seat of eight petals, with seat of transcendental lord in the cavity of his heart and formulation Brahma (ब्रह्मा) is of transcendental code value (29).

(ब्रह्मा)

$$(7+1+1+9+9+2 = 29)$$

ब्	-	अ	ह्	म्	आ
7	1	1	9	9	2

21. One shall sit comfortably and to permit the transcending mind to fully glimpse the phenomenon of re-manifestation of manifested format of hyper cube 4.
22. Hyper cube 4 as four folds manifestation layers (2, 3, 4, 5) of summation value 14 and hyper cube 14 as four folds manifestation layers 12, 13, 14, 15 of summation value 54 is of 29 versions.
23. One may have a pause here and take note that value 54 accepts organization as $54 = 27+27 = 3^3 + 3^3$.
24. Further as that, $29 = 16+13$.
25. One may have a pause here and take note that numbers range 1 to 16 leads to $16+13 = 29$ factors in all:

Number	Factors	Number of factors	Total factors
1	1	1	1
2	2	1	2
3	3	1	3
4	2x2	2	5
5	5	1	6
6	2x3	2	8
7	7	1	9
8	2x2x2	3	12
9	3x3	2	14
10	2x5	2	16
11	11	1	17
12	2x2x3	3	20
13	13	1	21
14	2x7	2	23

15	3×5	2	25
16	$2 \times 2 \times 2 \times 2$	4	29

26. It would be blissful to take note that there are 16 Ganita Sutras and 13 Ganita Upsutras.

27. One may further have a pause here and take note that dimensional frame of creator's space (4-space) is a set up of quadruple spatial dimension which lead to pair of organizations:

$$(i) \quad 2+2+2+2 = 8,$$

$$(ii) \quad 2 \times 2 \times 2 \times 2 = 16$$

28. One may further have a pause here and take note that:

$$(i) \quad \text{TCV (एक)} = 8$$

$$(ii) \quad \text{TCV (द्वय)} = 16$$

29. It would be blissful to comprehend and imbibe as that, manifestation of square with a feature of re-manifestation as interval and square within square, is the attainment which is the attainment of Vedic systems, for which the modern mathematical systems have to transit and transform to be in unison with the chase steps of Vedic Mathematics along the format of creator's space (4-space) of a spatial order.

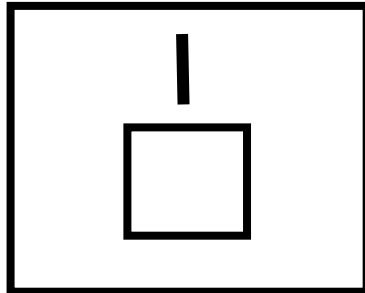

30. One shall further have a pause here and to take note that spatial order of creator's space accepts a two folds approach, firstly as '2 as 1' and second as '1 as 2'.
31. One shall sit comfortably and to permit the transcending mind to continuously remain in prolonged sitting of trans to glimpse and imbibe above values and features of Vedic Mathematics of creator's space.
32. It would be blissful to revisit two phased manifestation, firstly as hyper cube 4 and secondly as hyper cube 14.
33. One may have a pause here and take note that hyper cube 14 has 12-space in the role of dimension.
34. It would be very blissful to take note that:
- (i) TCV (एक) = TCV (त्रय) = TCV (चार) = 8
 - (ii) TCV (चतुर) = 12
 - (iii) TCV (चत्वार) = 20 = 8+12
35. One shall sit comfortably and to permit the mind to glimpse and imbibe above values and features of mathematics of format of creator's space (4-space) of spatial order.
36. It would further be blissful to take note that value 16 is parallel to the transcendental code values range 1 to 16 of the alphabet letters of devnagri alphabet.
37. It would further be blissful to take note that Creator's space has transcendental origin while transcendental domain itself is of self referral origin and transcendence of self referral origin of transcendental domain leads to split spectrum of values range (5, 6, 5) of summation value $5+6+5 = 16$.
38. Further as that, the re-manifestation phenomenon as of first phase of 1-space as dimension manifesting 3-space domain,

and at second stage of manifestation, 3-space as dimension manifests 5-space as domain.

39. One shall sit comfortably and to permit the transcending mind to glimpse and imbibe the organization of summation value (54 of four folds layer of hyper cube 14 (12, 13, 14, 15) as $12+15 = 13+14$, as the outer fold and inner fold of value 3^3 each will brings us face to face with the phenomenon of 27 Surya Nakshatras and 27 Chandar Nakshatras, a simultaneously parallel phenomenon of northern hemisphere and southern hemisphere of our solar universe.

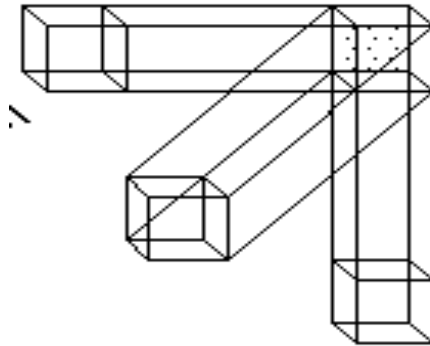

40. Sadhkas fulfilled with intensity of urge to glimpse and imbibe the way one may reach at the optimum reach of Vedic systems, one is to sequentially be through shad Vedangas and thereafter to be within the Vedic Samhita domain.



VEDIC MATHEMATICS FORMAT AND FORMAT OF MODERN MATHEMATICS

(त्रिपुण्ड्र) TRI-PUNDRAM

1. Tri-Pundram is the third Components of Om formulation.
2. Formulation (त्रिपुण्ड्र) Tri-Pundram accepts (41) as transcendental code value:

(त्रिपुण्ड्र) Tri-Pundram

$$(4+1+2+5+3+7+5+4+1+9 = 41)$$

त्	८	इ	प्	उ	ण्	ङ्	८	अ	॰
4	1	2	5	3	7	5	4	1	9

3. One may have a pause here and take note that value (41) avails a pair of digits (4), (1) for their placement along the ten place value format.
4. Quadruple Components in there sequence as Bindu Sarovar, Ardh Matra, Tri-Pundram, Swastik Pada accepts sequential placement value as (1, 2, 3, 4):

(बिन्दु सरोवर)		Bindu-Sarovar
(अर्धमात्रा)		Ardh Matra
(त्रिपुण्ड्र)		Tri-Pundram
(स्वास्तिक पाद) (सनातन)		Swastik Pada Sanatana

5. Sadhakas fulfilled with intensity of urge to glimpse and imbibe the distinctive feature of letter Raif (रेफ) (र), shall glimpse and imbibe following features and particulars:

- (i) Formulation Raif is of transcendental code value $16 = 3+6+6+1$.
- (ii) All other letter are (कार) of transcendental code value 7.
- (iii) Letter Raif (र) is of four folds:

रेफ (9+6)

1	2	3	4
---	---	---	---

- (iv) TCV (षोडष) = 26, while simple value rendering of this formulation is (16).

- (v) Quadruple values (1, 2, 3, 4) is of summation value $(1+2+3+4) = 10$.
 - (vi) Quadruple values as quadruple spaces 1-space, 2-space, 3-space, 4-space lead to dimensional frames of single, double, triple, quadruple dimensions making a set of 10 dimensions of (-1, 0, 1, 2) order, of summation value '2'.
 - (vii) The quadruple values (1, 2, 3, 4) as first manifestation (hyper cube 1, hyper cube 2, hyper cube 3, hyper cube 4) of four folds each, at the second manifestation make a set of $4 \times 4 = 16$ dimensions set.
 - (viii) The domain split spectrum, uptill first phase is of 4 stream, while the same uptill second split is of ten streams.
 - (ix)
6. One shall sit comfortably and to permit the transcending mind to glimpse and imbibe these values and features to acquire proper insight and to attain appropriate enlightenment about the distinctiveness of letter Raif.
 7. The quadruple value, 1, 2, 3, 4, is parallel to four folds manifestation layers (1, 2, 3, 4) of hyper cube 3.
 8. One shall sit comfortably and to permit the transcending mind to glimpse and imbibe the feature and value as that letter (ॠ) accepts association of value (3).
 9. The formulation Tri-Pundram is the third Components and is of TCV value 41, and the same as such, deserves to be comprehended fully in the set up of quadruple values (52, 54,

- 41, 36) of quadruple formulation of quadruple Components of Om formulation.
10. The pair of values (52, 41) leads to $52+41 = 93$ and $52-41 = 11$ value.
 11. Values pair (54, 41) leads to $54+41 = 95$ and $54-41 = 13$ value.
 12. The organization $54 = 27+27$, as such, brings to focus:
 - (a) $41 = 27+14$
 - (b) Hyper cube 4 as of spatial order with transcendental origin of solid order and there being split for the solid dimensional frame as a pair of solid dimensional frames of half dimensions of values pair $(3^3, 3^3)$
 13. One may have a pause here and take note that the hyper cube 4 as first manifestation (2, 3, 4, 5) is of summation value 14 and at second manifestation as hyper cube 14 (12, 13, 14, 15) is of value 54, the same at next manifestation as hyper cube 54 (52, 53, 54, 55) is of summation value 107.
 14. One may have a pause here and take note that $107 = 80+27$ and value 80 accepts organization as $80 = 8 \times 10$ which is parallel to 80 cubes envelop of entire creative boundary (4-space as boundary) of 10 Components of transcendental domain (5-space domain) of solid order.
 15. One may have a pause here and take note that the manifestation layers 52, 53, 54, 55 is of value 55 for its origin fold.
 16. Value $55 = 5 \times 11$ as such is the value of dimensional frames of 5 dimensions for each of 11 geometries of 5-space.

17. One may have a pause here and take note that $55 = 14+41$ and $14 = 2+3+4+5$, as such brings us face to face with the transcendental phenomenon of third phase of manifestation with in creator's space (4-space) of transcendental origin.
18. One may have a pause here and take note that double digit number of ten place values systems are accommodated by 9×11 grid, which splits as upper part and lower part and the upper part is having a mirror line (11, 22, 33, 44) while the lower part is having a mirror line (55, 66, 77, 88, 99).
19. It will be a blissful exercise to visit the organization format of upper part and to tabulate its reflection pair including self reflection artifices along the mirror line as a set up of 29 such pairs which accepts classification as 16 pairs and 13 pairs respectively parallel to the organization of 16 Ganita Sutras and 13 Ganita Upsutras.
20. It would further be blissful exercise to tabulate reflection pair set up of the lower part with its mirror line (55, 66, 77, 88, 99) sublime penta self reflecting pairs of values (55, 66 77, 88, 99).
21. For convenient reference the tabulation of double digit number as 9×11 grid is being reproduced as under:

01	02	03	04	05	06	07	08	09
10	(11)	12	13	14	15	16	17	18
19	20	21	(22)	23	24	25	26	27
28	29	30	31	32	(33)	34	35	36
37	38	39	40	41	42	43	(44)	45
46	47	48	49	50	51	52	53	54
(55)	56	57	58	59	60	61	62	63
64	65	(66)	67	68	69	70	71	72
73	74	75	76	(77)	78	79	80	81
82	83	84	85	86	87	(88)	89	90
91	92	93	94	95	96	97	98	(99)

VEDIC MATHEMATICS FORMAT AND FORMAT OF MODERN MATHEMATICS

(स्वास्तिक पाद) SWASTIK PADA

1. Formulation (स्वास्तिक पाद) Swastika pada is of transcendental code value $23+14 = 37$.

(स्वास्तिक पाद)

$$(3+7+2+3+4+2+1+1+5+2+6+1 = 23+14)$$

स्	व्	आ	स्	त्	इ	क्	अ	प्	आ	द्	अ
3	7	2	3	4	2	1	1	5	2	6	1

2. One may have a pause here and take note that the formulation (श्रीभगवान) Sri Bhagwan = 37.
3. One may have a pause here and take note that value 37 accepts organization as $37 = 2 \times 18 + 1$, which is parallel to 37 versions of hyper cube 18 as representative regular body of 37 geometry of 18-space.
4. Value 23 is of organization $23 = (3+5) + (3 \times 5)$, which is parallel to summation value of addition and product of pair of values (3, 5) parallel to 3-space as dimension of 5-space.
5. Value 14 is of organization $14 = 2+3+4+5$, which is parallel to four folds manifestation layers (2, 3, 4, 5) of hyper cube 4, the representative regular body of 4-space with 5-space in the role of origin.

6. One may have a pause here and to permit the transcending mind to continuously remain in prolonged sitting of trans and to glimpse and imbibe above values and features of the set up of hyper cube 4 with transcendental origin.

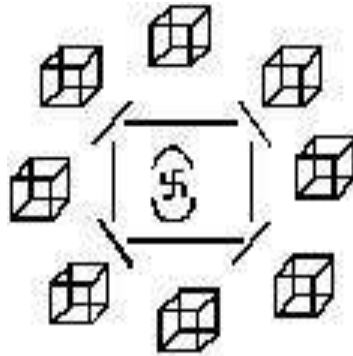

7. One may further have a pause here and take note that Swastik (23) as Pada (quarter) will bring us face to face with the set up of value $23 \times 4 = 92$.
8. One may further have a pause here and take note that value $23 \times 4 = 92$ is parallel to splits spectrum of domain (25).

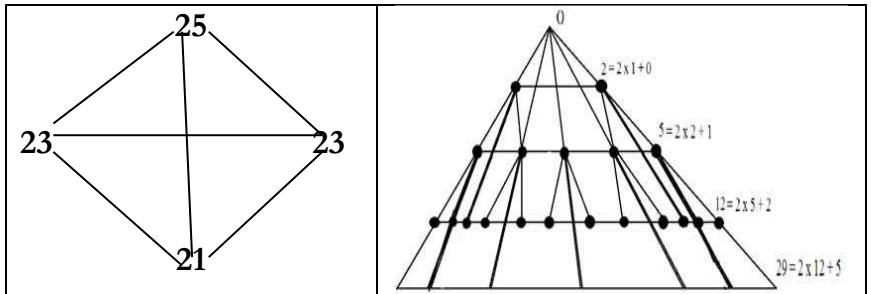

9. Sadhakas fulfilled with intensity of urge to acquire proper insight and to attain appropriate enlightenment about these organization format features and values shall be face to face with the following word formulations as well:
- (i) **25** = TCV (विष्णु) (बुद्धि) (पृथ्वी) (दुःख) (भूमि)
- (ii) **23** = TCV (जन्म) (अन्नत) (सहस्र)
- (iii) **21** = TCV (मृत्यु) (ज्ञान) (तत्त्व) (आरम्भ) (पुराण)
10. One may have a pause here and to permit the transcending mind to glimpse fully the phenomenon of split of domain-28 as a pair of stream of value (26) each.
11. It would be blissful to take note that value 28 is parallel to transcendental code value of formulation Brahm (ब्रह्म) = 28, while values pair (26, 26) is parallel to TCV value (बिन्दु सरोवर).
12. It would further be blissful to glimpse and imbibe four folds manifestation layers (23, 24, 25, 26) of hyper cube 25.
13. Here, space 23 plays the role of dimension while space 26 plays the role of origin of hyper cube 25.
14. One shall sit comfortably and to chase Divya Ganga parvaha from Bindu Sarovar (बिन्दु सरोवर) and its reach within Pushpika (hyper cube 4) uptill its transcendental origin, and transcendence back from transcendental origin of pushpika and its reach back uptill orb of the Sun, the seat of Bindu Sarovar of Sole Syllable Om.
15. Sadhakas fulfilled with intensity of urge to glimpse and imbibe this phenomenon shall glimpse and imbibe the

organization format of Srimad Bhagwad Geeta being of the format and features of Divya Ganga Parvaha along the artifices of the Component sole Syllable Om.

16. And, the organization format of Sama Ved Samhita being of the format and feature of transcendence upward from the transcendental origin and its reach uptill orb of the Sun as a seat of (बिन्दु सरोवर).



VEDIC MATHEMATICS

(MATHEMATICS OF (पिण्ड) PINDA)

Word formulation (पिण्ड) (*Pinda*) /Body / Human body)

1. Word formulation (पिण्ड) is a composition availing 5 letters of transcendental code values (5, 2, 7, 5, 1) of summation value (20).

(पिण्ड)

$$(5+2+7+5+1 = 20)$$

प्	इ	ण्	ङ्	अ
5	2	7	5	1

2. First letter (प्) is of transcendental code value (5) and parallel to it is 5-space, and the same as per the placement of letter (प्) as first letter of the fifth row of varga consonant is of format of 5-space in the role of dimension making it a transcendental dimensional order of unity state (7-space domain).
3. Second letter (इ) is of transcendental code value (2), the same is of format of dimensional frame of 2-space, which as such is a set up of a pair of dimensions of zero order.
4. Third letter (ण्) is of transcendental code value (7), parallel to which is 7-space, which as per the placement of letter (ण्) is of the format of 7-space as base fold of hyper cube 5.

5. 4th letter (इ) is of transcendental code value (5), parallel to which is 5-space, which as per the placement of letter (इ) is in the role of 5-space as domain fold of hyper cube 5.
6. 5th letter (अ) is of transcendental code value (1), parallel to which is 1-space, and same as per placement of letter (अ) is of the format of a dimensional frame of 1-space, which is of format and features of single dimension of negative linear order (-1-space in the role of dimension of 1-space).

NUMBER VALUE 20

7. Number value 20 is parallel to transcendental code value 20 of formulation Ved (वेद), as well as of formulation (देव) Dev.
8. One may have a pause here and take note that value 20 is parallel to synthesis value 20 of a pair of transcendence range of zero order: $[(0+1+2+3+4)+(0)+(0+1+2+3+4)]$.
9. One may further have a pause here and take note that the summation of values of single, double, triple and quadruple dimension synthetic set up of for every order, comes to be '20':

$$\{N\} + \{N+2\} + \{6\} + \{-2N-12\} = 20, \text{ for all value of } N.$$
10. Still further, as $0+0 = 0 = 0 \times 0 = (-0) \times (-0) = (-0)$, as such the orientation gets dissolved in zero order set ups.
11. Still further, $2+2 = 4 = 2 \times 2 = (-2) \times (-2)$, as well dissolves orientations in a spatial order 4-space.
12. One shall sit comfortably and to permit the transcending mind to continuously remain in prolonged sitting of trans and

to glimpse and imbibe the above values and features of creator's space (4-space) which is of spatial dimensional order (2-space in the role of dimension of 4-space) and these also of zero dimension of dimension, 0-space plays the role of dimension of 2-space and dimension of dimension of 4-space.

13. It would be blissful to glimpse value 20 in reference to value (-20).
14. It would be blissful to visit organization of value (-20) as [-7, -7, -6].
15. One may have a pause here and take note that this set up and organization (-7, -7, -6) in its reverse orientation as (7, 7, 6) is parallel to the set up of word formulation (पिण्ड) Pind being of transcendental code values [(5+2 = 7), (7), (5+1 = 6)].
16. One shall sit comfortably and to permit the transcending mind to continuously remain in prolonged sitting of trans and to glimpse and imbibe the above format and feature to imbibe them completely for fully appreciation to acquire proper insight and to attain appropriate enlightenment about the organization format of word formulation (पिण्ड).

CIRCUMFERENCE FORMAT FOR VALUES RANGE

(2, 5, 7, 5, 1)

17. Sadhakas fulfilled with intensity of urge to fully glimpse and to completely imbibe the organization format of composition

of word formulation (पिण्ड) shall visit it in the sequence and placement of letters as:

(पिण्ड)

$$(2+5+7+5+1 = 20)$$

इ	प्	प्	इ	अ
2	5	7	5	1

18. Let us have a transition and transformation from that of a line to that a circumference:

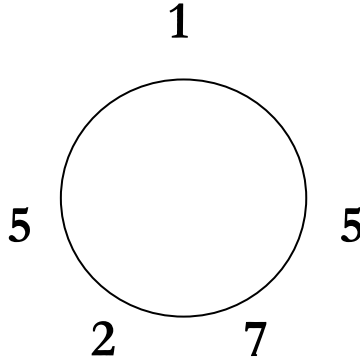

19. One may have a pause here and take note that from value '1' we shall be having twin progression flow, firstly as of reach (1, 5, 2) and second as of (1, 5, 7).

20. One may have a pause here and to have a visit to the set up of Divya Ganga Prahvaha along the artifices of Component of sole syllable Om (ॐ) (Bindu Sarovar, Ardh Matra, Tri-Pundram and Swastik Pada).

From the bindu Sarovar flow 7 streams and with the reach uptill second Component.

21. One may have a pause here and take note that Bindu Sarovar as first Component accepts association of value (1), and in a sequence, second Component (Ardh Matra accepts association of number value (2).
22. One may have a pause here and take note that from first Component there is going to be a reach second Component.
23. And, simultaneously from first Components there is going to be a reach as of seven stream flow emanating from the Bindu Sarovar (first Component).
24. This as such, makes first path as of values pair (1, 2).

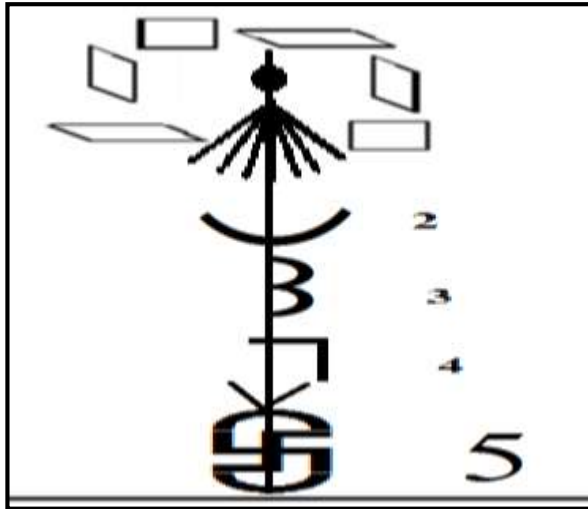

25. Simultaneously, it also leads to second progression path of values pair (1, 7).
26. One may further have a pause here and to glimpse and imbibe the format and features of the above organization of 7

- streams fulfilling the space between first Component (Bindu Sarovar) uptill the second Components (Ardh Matra).
27. As such, with first Components, as the first end point of the covered domain, and the second Components as the second end point of covered domain, a reach from both end, will help us comprehend and imbibe the format and feature of the composition of formulation (पिण्ड) availing pair of vowels (अ, इ), as a pair of end letters of the composition (पिण्ड) as of five letters in all.
 28. One may have a pause here and take note that from both end, the inward progression, in both cases, is at value '5' as the letters (ऋ) and (ॠ), both of them accept value (5) each.
 29. One may have a pause here and take note that dimensional synthesis equation $(5, 5) = (7)$ will help us appreciate as to the reach at the inner most letter (ऋ) is going to be value (7).
 30. One may further have a pause here and take note that values pair (2, 5) are also interconnected and interrelated as that 2-space as 5 geometries range and parallel to it hyper cube 2 / square is of 5 versions making a set of 5 representative regular body of 2-space.
 31. Further, values pair (5, 7) is interconnect and interrelated as of format of 5-space in the role of dimension of 7-space domain.
 32. Still further, it also would be relevant to take note that 3-space plays the role of origin of 2-space and 3 dimensional frames accepts split as a pair of 3 dimensional frames of half dimensions.

33. Further as that, pair of solid dimensions (3, 3) lead to synthesis value (5) as synthesized domain (3, 3) = (5).

REACH FROM PIND (पिण्ड) TO BRAMAND (ब्रह्माण्ड)

34. Sadhakas fulfilled with intensity of urge to completely comprehend and fully appreciate the organization of word formulation () Pind shall sit comfortably and to permit the transcending mind to glimpse and imbibe the format features of five steps long composition of formulation Pind as format of word formulation Brahmand (ब्रह्माण्ड) of transcendental code value '42'.
35. One may have a pause here and take note that value (20) accepts organization as $20 = 6+14$.
36. Value 42 accepts organization as $28+14$
37. One may have a pause here and take note that value six is the value of first perfect number while value 28 is value of the second perfect number.
38. Further as that, first perfect number value 6 accepts only 3 proper divisors (1, 2, 3) while second perfect number (28) accepts five divisors (1, 2, 4, 7, 14).
39. Further, as that, prime three is the biggest prime proper divisor of number 6, while prime 7 is the biggest prime proper divisor of number 28.
40. One may have a pause here and take note that number value 42 is the synthesis value of a pair of spatial order transcendence ranges: $[(2+3+4+5+6)+(2)+(2+3+4+5+6)] = 42$.

41. One may have a pause here and take note that value 42 accepts organization as $[(1+2+3+4+5+6)+(1+2+3+4+5+6)] = 42$, which is parallel to twice application of Sathapatya measuring rod synthesized by hyper cubes 1 to 6 parallel to swapping of 6-space domain.
42. One shall sit comfortably and to permit the transcending mind to glimpse and imbibe above format and features of pair of formulation Pind (पिण्ड) and Bramand (ब्रह्माण्ड).

(ब्रह्माण्ड)

$$(7+1+1+9+9+2+7+5+1 = 42)$$

ब्र	७	अ	ह	म्	आ	ण्	ड्	अ
7	1	1	9	9	2	7	5	1

43. One may have a pause here and take note that the word formulation (ब्रह्माण्ड) is a composition of nine letters and three syllables of three letters each of transcendental code values triple $(7+1+1, 9+9+2, 7+5+1)$.
44. One shall sit comfortably and to permit the transcending mind to glimpse and imbibe the values and features of triple transcendental code values $(9, 20, 13)$.
45. Values triple $(9, 20, 13)$ in a sequential format as $(9, 13, 20)$ is of organization feature $(9, 9+4, 9+7+4)$.
46. Value 9 is parallel to 9 versions of hyper cube 4.
47. Value 13 is parallel to the transcendence of transcendence spectrum of transcendental origin of 4-space $(4+5+4)$.
48. Value 20 is parallel to the synthesis of single, double, triple and quadruple synthetic set up of self referral dimension (6-space as dimension).

49. One may have a pause here and take note that single self referral dimension contribute value '6'.
50. Pair of self referral dimensions contribute value '8'.
51. Triple self referral dimensions contribute value '6'.
52. Quadruple self referral dimensions contribute value '0'.
53. One may have a pause here and take note that as the quadruple self referral dimension contribute only value zero, as such the contribution of single, double and triple self referral dimensions comes to be (20).
54. One may further have a pause here and take note that 5-space is a solid order space (3-space plays the role of dimension of 5-space).
55. Solid dimensional order (3-space as dimension) structure four folds manifestation layer (3, 4, 5, 6) of hyper cube 5 with 6-space in the role of origin of 5-space.
56. One shall sit comfortably and to permit the transcending mind to continuously remain in prolonged sitting of trans and to glimpse and imbibe the transcendental phenomenon of transcendental origin of creator's space transcending out from within the 9th versions of hyper cube 4, and a step ahead, there to be the transcendence of self referral origin of transcendental origin and making the Pinda format as the manifestation format of Brahand.
57. Sadhaks fulfilled with intensity of urge to imbibe these values and features of shall continuously remain in prolonged sitting of trans.



7

Devnagri Alphabet

देवनागरी वर्णमाला

Nine Vowels स्वरः

अ इ उ ऋ लृ ए ओ ऐ औ

१ २ ३ ४ ५ ६ ७ ८ ९

१ २ ३ ४ ५ ६ ७ ८ ९

5 x 5 Varga consonants वर्गाः

कवर्ग (कु)

क् ख् ग् घ् ङ्

१ २ ३ ४ ५

चवर्ग (चु)

च् छ् ज् झ् ञ्

२ ३ ४ ५ ६

टवर्ग (टु)

ट् ठ् ड् ढ् ण्

३ ४ ५ ६ ७

तवर्ग (तु)

त् थ् द् ध् न्

4 5 6 7 8

पवर्ग (पु)

प् फ् ब् भ् म्

5 6 7 8 9

Anthstha letters:

य् र् ल् व्

अन्तस्थ

1 3 5 7

Ushmana letters:

श् स् ष् ह्

उष्मणः

2 3 6 9

Yama letters यमः

9 10 11 12 13 14 15 16



LETTER BY LETTER CHASE

CONTENT

7. Devnagri alphabet with TCV value
8. Ashtadhaiya format
9. Domains 1 to 9
10. Formulation Shruti
11. Drishta
12. Letter by letter Chase

1

Devnagri Alphabet

देवनागरीं वर्णमाला

Nine Vowels स्वरः

अ इ उ ऋ लृ ए ओ ऐ औ

१ २ ३ ४ ५ ६ ७ ८ ९

1 2 3 4 5 6 7 8 9

5 x 5 Varga consonants वर्गाः

कवर्ग (कु)

क् ख् ग् घ् ङ्

1 2 3 4 5

चवर्ग (चु)

च् छ् ज् झ् ञ्

2 3 4 5 6

टवर्ग (टु)

ट् ठ् ड् ढ् ण्

3 4 5 6 7

तवर्ग (तु)

त् थ् द् ध् न्

4 5 6 7 8

पवर्ग (पु)

प् फ् ब् भ् म्

5 6 7 8 9

Anthstha letters:

य् र् ल् व्

अन्तस्थ

1 3 5 7

Ushmana letters:

श् स् ष् ह्

उष्मणः

2 3 6 9

Yama letters यमः

9 10 11 12 13 14 15 16



2

ASHTADHIYAI FORMATS

1. Sadhakas fulfilled with intensity of urge to glimpse and imbibe the values and features of organization format of the text of Ashtadhiyai shall first of all reach at transcendental code value of words formulations of Ashtadhiyai.
2. Formulation (अष्टाध्यायी) accepts transcendental code value '27'

अष्टाध्यायी

$$1+6+3+2+7+1+2+1+4 = 27$$

अ	ष	ट्	आ	ध्	य्	आ	य्	ई
1	6	3	2	7	1	2	1	4

3. One may have a pause here and take note that value 27 accepts organization $27 = 3 \times 3 \times 3$.
4. Further as that, $27+27 = 54$.
5. Value 54 as $27+27$ is parallel to the organization of $(3^3, 3^3)$.
6. This organization is further of format feature of a three dimensional frame of 3 solid dimensions, splitting into a pair of 3 dimensional frames of half dimensions.
7. One may have a pause here and to permit the transcending mind to glimpse and imbibe these values and features.
8. Text of Ashtadhiyai is composed as sutras.

9. Formulation Sutra (सूत्र) accepts transcendental code value 15

$$\text{सूत्र}$$

$$3+6+4+1+1=15$$

स्	ऊ	त्	-	आ
3	6	4	1	1

10. One may have a pause here and take note that value 15 accepts organization as $1 \times 3 \times 5$ which is parallel to the value of solid dimensional frame of 5 dimensions of transcendental domain (5-space domain).
11. One may have a pause here and take note that formulation (सूत्र) is a composition of a pair of syllables (i) (सू) and (ii) (त्र) of a pair of transcendental code values (9, 6)
12. One may further have a pause here and take note that values pair (9, 6) accepts organization as $(3 \times 3, 3+3)$.
13. One shall sit comfortably and to permit the transcending mind to glimpse this values and feature of addition and multiplication of solid dimension (value 3).
14. First sutra of the text of Ashtadhiyai is sangya sutra and the second sutra as well is sangya sutra while first sutra is about virdhi sangya (वृद्धि संज्ञा) and second sutras is about guna sangya (गुण संज्ञा).
15. One shall sit comfortably and to permit the transcending mind to comprehend and imbibe these values and features.

16. Sadhakas fulfilled with intensity of urge to glimpse and imbibe the values and features of organization of the text of Ashtadhiyai shall reach at one's own TCV dictionary of word formulation of the text of Ashtadhiyai.
17. Word formulation (वृद्धि) accepts transcendental code value 26

(वृद्धि)

$$7+4+6+7+2 = 26$$

व्	ऋ	द्	ध्	इ
7	4	6	7	2

18. Formulation (गुण) accepts transcendental code value 14

(गुण)

$$3+3+7+1 = 14$$

ग्	उ	ण्	आ
3	3	7	1

19. One may have a pause here and take note that value 26 accepts organization as $26 = 14+12$.
20. Value 14 is parallel to TCV value 14 of formulation Satha (सत्ता) and value 12 is parallel to transcendental code value 12 of formulation (योग).

21. Value 26 as 14+12 leads us to transcendental code value of formulation (सत्ता योग)

(सत्ता योग)

$$(3+1+4+4+2+1+7+3+1 = 26)$$

स्	आ	त्त	त्त	आ	य्	टो	ग्	आ
3	1	4	4	2	1	7	3	1

22. One shall have a pause here and to glimpse and imbibe reach at value 25 as value of formulation (संज्ञा)

(संज्ञा)

$$3+1+9+4+6+2 = 25$$

स्	आ	।	ज्	ज्	आ
3	1	9	4	6	2

23. One shall sit comfortably and to permit the transcending mind to glimpse and imbibe above values and features of referred formulation.
24. Formulation (वृद्धि) in sutra-1 and formulation (वृद्धी) availed in sutra-3 are of transcendental code values pairs (26, 29).
25. One may have a pause here and take note that values pair (26, 29) is the end pair value of quadruple value (26, 27, 28, 29) parallel to four folds manifestation layer (26, 27, 28, 29) of hyper cube 28.

26. Quadruples values (26, 27, 28, 29) are parallel to quadruple transcendental code values of quadruple formulation (Devta (देवता), Prarabdh (प्रारब्ध), Brahm (ब्रह्म), Brahma (ब्रह्मा)).
27. One shall sit comfortably and to visit and revisit these formulation and to fully comprehend and to completely imbibe these values and features to acquire proper insight and to attain appropriate enlightenment about the formats of different words formulation of the text of Ashtadhiyai.

(देवता)

$$(6+6+7+1+4+2 = 26)$$

द	ए	व	आ	त्	आ
6	6	7	1	4	2

(प्रारब्ध)

$$(5+1+2+3+1+7+7+1 = 27)$$

प्	-	आ	र्	अ	ब्	ध्	आ
5	1	2	3	1	7	7	1

(ब्रह्म)

$$(7+1+1+9+9+1= 28)$$

ब्र	-	अ	ह्र	म्	अ
7	1	1	9	9	1

(ब्रह्मा)

$$(7+1+1+9+9+1= 28)$$

ब्र	-	अ	ह्र	म्	आ
7	1	1	9	9	2

28. One may have a pause here and take note that to permit the transcending mind to continuously remain in prolonged sitting of trans and to glimpse and imbibe above values and features and to completely comprehend and to fully imbibe as that lord Brahma is the over lord of real 4-space which of a spatial order and format and feature of idol of lord Brahma are parallel to format and features of hyper cube 4 which is a four folds manifestation layer (2, 3, 4, 5) of summation value $2+3+4+5 = 14$ and hyper cube 14 is of 29 versions.
29. One shall further sit comfortably and to permit the transcending mind to glimpse and imbibe the distinct set ups of interval and square as representative regular bodies of 1-space and 2-space



30. And further as that, interval and square also manifests within a square.

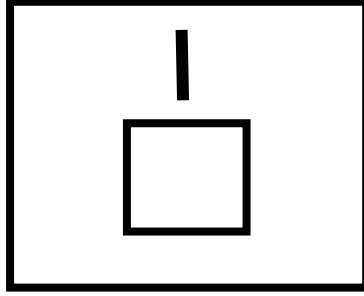

31. It is this feature of independent but sequential existence of interval and square, also having simultaneous existence as a interval and square within a square, which deserves to be comprehended well.
32. One may have a pause here and take note that interval being the format of sutra-1.
33. Square is the format of sutra-2.
34. Interval and square within a square format of sutra-3.
35. One shall sit comfortably and to permit the transcending mind to glimpse and fully imbibe these values and features of format of sutras 1, 2 and 3 of Ashtadhiyai.
36. One may have a pause here and take note that sutars are of six different types.
37. First type of sutras are the sangya sutras with formulation Sangya being if transcendental code value 25.
38. Second type of sutras are pribasha sutras and formulation Pribasha is of transcendental code value 29.

39. One may have a pause here and take note that pair of values (25, 29) and the end pair of values are the transcendence range (25, 26, 27, 28, 29).
40. Value 25 is parallel to the transcendental code values of formulations Vishnu (विष्णु), Prithivi (पृथ्वी), Bhumi (भूमि), Bhuma (भूमा), Budhi (बुद्धि) and Dukha (दुःख).
41. The summation value of values of transcendence range 25, 26, 27, 28, 29 is $25+26+27+28+29 = 135$.
42. Value 135 accepts organization as $135 = 5 \times 27 = 5 \times 3^3$ which is parallel to the set up of five half dimensions of three dimensional frame of value 27 each.
43. One shall sit comfortably and to permit the transcending mind to glimpse and imbibe these values and features.
44. It would further be blissful to visit and revisit which avails 135 (1, 3, 5) parallel to 5-space domain is of solid dimensional frame and linear dimensions of dimensions.
45. The summation value $1+3+5 = 9$ and product value $1 \times 3 \times 5 = 15$, brings us face to face with formulation swara which accepts transcendental code value 15 and there are 9 swaras.

Vowels

अ इ उ ऋ लृ ए ओ ऐ औ

1 2 3 4 5 6 7 8 9

(स्वर)

(3+7+1+3+1 = 15)

स्	व्	अ	र्	अ
3	7	1	3	1

(विष्णु)

$$(7+2+6+7+3 = 25)$$

व्	इ	ष्	ण्	उ
7	2	6	7	3



3

DOMAINS 1 TO 9

1. Domains 1 to 9 are the domains fold of hyper cubes 1 to 9.
2. Hyper cubes 1 to 9 are four folds manifestation layer : $(-1, 0, 1, 2)$, $(0, 1, 2, 3)$, $(1, 2, 3, 4)$, $(2, 3, 4, 5)$, $(3, 4, 5, 6)$, $(4, 5, 6, 7)$, $(5, 6, 7, 8)$, $(7, 8, 9, 10)$.
3. These four folds manifestation layer have $(-1, 0, 1, 2, 3, 4, 5, 6)$ as their respective dimension fold.
4. $(0, 1, 2, 3, 4, 5, 6, 7, 8)$ are the boundary folds.
5. $(1, 2, 3, 4, 5, 6, 7, 8, 9)$ are the domains fold.
6. $(2, 3, 4, 5, 6, 7, 8, 9, 10)$ are the origin fold.
7. Origin folds are within domain folds and are of placement at centre of the domains fold.
8. Centre of the domain fold is a dual status, firstly as constituent of domain space, and secondly as of next higher dimensional space of role of origin.
9. This leads to values $(1+2 = 3)$, $(2+3 = 5)$, $(3+4 = 7)$, $(4+5 = 9)$, $(5+6 = 11)$, $(6+7 = 13)$, $(7+8 = 15)$, $(8+9 = 17)$ and $(9+10 = 19)$ as values of domains with origins are 1-space to 9-space with 2-space to 10-space as origins.
10. One may have a pause here and take note that values 3, 5, 7, 9, 11, 13, 15, 17, 19 are parallel to respective geometric ranges of 1-space to 9-space.
11. These values are also parallel to respective versions of hyper cubes 1 to 9.

12. One may have a pause here and take note that with transcendence of origin from the domain folds the same leads to transcendence format of triple values in respect of these 1 domain to 9-space.
13. These transcendence triples are of values (1, 2, 1) (2, 3, 2), (3, 4, 3), (4, 5, 4), (5, 6, 5), (6, 7, 6), (7, 8, 7), (8, 9, 8), (9, 10, 9).
14. One may have a pause here and take note that these triples lead to summation values (4, 7, 10, 13, 16, 19, 22, 25, 28).
15. One may further have a pause here and take note that beginning with value 4 having reach at value 28 is a 7 steps long reach up-till value 28 which is parallel to transcendental code value 28 of formulation Braham.
16. One may further have a pause here and take note that each of these triple values spectra of these 9 domains results into a split of two parts each:
 $\{1, 2\}, \{2, 1\}, \{2, 3\}, \{3, 2\}, \{3, 4\}, \{4, 3\}, \{4, 5\}, \{5, 4\}, \{5, 6\}, \{6, 5\}, \{6, 7\}, \{7, 6\}, \{7, 8\}, \{8, 7\}, \{8, 9\}, \{9, 8\}, \{9, 10\}, \{10, 9\}$.
17. One may have a pause here and take note that spit of each of above 9 domain spectra into a pair of parts, as such, is of reflection pairs organization like (1, 2) and (2, 1).
18. This at first instance leads us to values pairs (3, -3), (5, -5), (7, -7), (9, -9), (11, -11), (13, -13), (15, -15), (17, -17), (19, -19).
19. One may have a pause here and take note that values pairs (3, -3) is parallel to a split of 3 dimensional frame of linear order into a pair of 3 dimensional frame of half linear dimension of opposite orientations.

20. Likewise, is the split of dimensional frame of 5, 7, 9, 11, 13, 15, 17 and 19 dimensional frame.
21. One shall sit comfortably and to permit the transcending mind to continuously remain in prolonged sitting of trans to glimpse and imbibe above values of domains 1 to 9.
22. One may have a pause here and take note that domain is the space content manifested as domain fold of respective hyper cubes as representative regular body of respective space.
23. The domain fold, as such plays its difference roles of which the first role is as of dimension fold.
24. The domain of 1-space plays the role of dimension of 3-space.
25. Likewise the domain fold of 7-space plays the role of dimension of 9-space.
26. One shall sit comfortably and to permit the transcending mind to glimpse and imbibe these values and features.
27. Further one shall glimpse 9 gaps of ten points range making ten points together with 9 gaps set ups as a value $10+9 = 19$.
28. N points with N-1 gaps make a set up of $2N-1$ value for values of $N = 1$ to 9.
29. One shall glimpse and imbibe these set ups of values 1 to 19.
30. One may have a pause here and take note that value $1 = 2x0+1$ brings us face to face with the set up of a pair of point and gap in-between as of value '1'.
31. It is here where one shall go for re-visit and to permit the transcending mind to continuously remain in prolonged sitting of trans and to glimpse and imbibe the zero space with 1-space as origin.

32. It would be blissful to visit the set up of interval as a set up of points of 1-space with 0-space points as its gaps.
33. It is this dual status for 0-space domain and 1-space domain in the same set up with deserves to be comprehended well.
34. One shall sit comfortably and to permit the transcending mind to glimpse and imbibe these values and features fully glimpse and to imbibe them completely to acquire proper insight and to attain appropriate enlightenment about such set ups.



4

FORMULATION

श्रुतिः (SHRUTI)

1. Sadhakas fulfilled with intensity of urge to glimpse and imbibe values and virtues of (वेद) (Ved) shall permit the transcending mind to glimpse and imbibe the values and features of formulation श्रुतिः (Shruti).
2. Formulation Shruti accepts transcendental code value (25):

श्रुतिः

$$(2+1+3+4+2+13 = 25)$$

श्र	-	उ	त्	इ	:
2	1	3	4	2	13

3. One may have a pause here and take note that this composition, as such is of 6 steps, and the same avails:

(i) Letter (श्र)

First Ushmana letter (श्र) of transcendental code value (2).

(ii) Letter (-)

Second Anthasatha letter (-) of transcendental code value (1).

Here it would be relevant to take note that second anthasatha

letter (ॠ) / Raif) is of three sequential evaluation phases (ॠ, ॡ, ॢ) accepting transcendental code values triple (1, 2, 3).

(iii) Letter (ॢ)

Third vowel (ॢ) of transcendental code value (3).

(iv and v) letter (ॣ, ।)

Fourth varga row letter (ॣ) accepting transcendental code value (4). Here it would be relevant to take note that parallel to value 4 is format of 4-space, which is of a spatial order. Here it also would be relevant to take note that fifth letter of formulation (श्रुतिः) Shrutī is second vowel (।) is of transcendental code value 2. Further it also would be relevant to take note that quadruple values (1, 2, 3, 4) as such accept factors (1, 2, 3, 2x2), which make of value (5). Still further it also will be relevant to take note that 2-space is of 5 geometries range and hyper cube 2, the representative regular body of 2-space in 4-space is of 5 versions.

(vi) letter (ः)

Fifth Yame letter (ः) accepts transcendental code value (13). Here it would be relevant to take note that numbers (1, 2, 3, 4, 5) accepts factors (1, 2, 3, 2x2, 5), which makes total factors being 6.

4. One may have a pause here and to sit comfortably and to permit the transcending mind to continuously remain in prolonged sitting of trans and to fully glimpse and imbibe above values and features of the organization of the composition of formulation (श्रुति) Shrutu as of six steps availing first Ushamana letter, second anthsatha letter, third vowel, forth varga consonant together with second vowel and fifth yama letters.
5. Formulation (श्रुति) is a composition of 5 letters of transcendental code value range (2, 1, 3, 4, 2) of summation value $2+1+3+4+2 = 12$.
6. One may have a pause here and take note that value 12 is parallel to the transcendental boundary (5-space boundary) of twelve Components of the self referral domain (6-space domain).
7. It would further be relevant to take note that self referral domain 6-space domain is of 13 versions of making representative regular body of 13 geometry of 6-space.
8. It would further be relevant to take note that range of 13 points has 12 gaps.
9. The set up of 13 points together with 12 gaps makes a set up of $13+12 = 25$ values set up.
10. One may further have a pause here and take note that value 25 accepts organization as $25 = 5 \times 5$.
11. It would be blissful to take note that transcendental boundary of 12 Components of self referral domain with its split and organization as $12 = 5+7$ brings us face to face with the

emerging format (5, 7) as parallel to the format of (5-space dimension, 7-space domain).

12. It further bring us face to face with the set up of 5x7 grid which accommodate all the 35 double digit numbers of 6 place value system

01	02	03	04	05	
10	11	12	13	14	
15	20	21	22	23	
24	25	30	31	32	
33	34	35	40	41	
42	43	44	45		100

13. One may have a pause here and take note that 36th number of 6 place value system is of value expression (100) of 6 place value system.
14. One may further have a pause here and take note that this as such becomes Anubhandh (upper block) for the double digit number of 6 place value systems.
15. Formulation (अनुबन्ध)/Anubandh is of transcendental code value (36).

(अनुबन्ध)/Anuband

$$(1+8+3+7+1+8+7+1 = 36)$$

अ	न्	उ	ब्	अ	न्	ध्	अ
1	8	3	7	1	8	7	1

16. One may have a pause here and take note that formulation (अनुबन्धः) Anubandh is of transcendental code value 49 which accepts organization $49 = 7 \times 7$, and it is for this reach from $36 = 6^2$ to $49 = 7^2$ that there is (इत्) (IT) operation / the operation of removal of Anubandh comes into play.
17. Formulation (इत्) is of transcendental code value (6) and parallel to it 6-space domain is of 13 versions as representative regular bodies of 13 geometries range of 6-space
18. One may have a pause here and take note that 7 points range has 6 gaps and the set up of 7 points together with 6-space makes a set up number value 13 parallel to 13 geometries range of 6-space with their representative regular bodies being format and features of 13 versions of hyper cube 6.
19. A reach from 6-space domain to 7-space domain is a reach of the format and feature of the set up of hyper cube 7 as 7-space domain enveloped within self referral boundary (6-space boundary) of 14 Components.
20. Here it would be blissful to take note that formulation (सप्त) / sapt, seven) is (14).
21. It would further be blissful to take note that of 14 anubandhas (अनुबन्धः) of 14 Maheshwara sutras (महेश्वरः सूत्राङ्ग) are being only 13 of them being the distinct anubandh and the first anubandh repeating itself as the anubandh.

22. One shall sit comfortably and to permit the transcending mind to continuously remain in prolonged sitting of trans to glimpse and imbibe the above organization values and features to acquire proper insight and to attain appropriate enlightenment about organization format of Vedic knowledge and Vedic Samhitas.

23. 14 Anubandhs of 14 Maheshwara sutras are:

MAHESHWARA SUTRAS WITH TCV

S.N.	Sutra letters / anubandh	TCV value
1.	(अ इ उ) ण्	(1, 2, 3) (7)
2.	(ऋ लृ) क्	(4, 5) (1)
3.	(ए ओ) ङ्.	(6, 7) 5
4.	(ऐ औ) च्	(8, 9) (2)
5.	(ह य व र) ट	(9, 1, 7, 3) (3)
6.	(ल) ण्	(5) (7)
7.	(ज म ङ ण न) म्	(6, 9, 5, 7, 8) (9)
8.	(झ भ) ज	(5, 8) (6)

9.	(घ ढ ध) ष्	(4, 7, 9) (6)
10.	(ज ब ग ड द) श्	(4, 7, 3, 5, 6) (2)
11.	(ख फ छ ठ थ च ट त) व्	(2, 6, 3, 4, 5, 2, 3, 4) (7)
12.	(क प) य	(1, 5) (1)
13.	(श ष स) र	(2, 6, 3) (3)
14.	(ह) ल्	(9) (5)

24. To further acquire insight about the values and features of the organization format of formulation (श्रुति) Shruti one shall visit and revisit it and glimpse and imbibe the sequential placement of its letters and respective transcendental code values:

श्रुति

$$(2+1+3+4+2 = 12)$$

श्	-	उ	त्	इ
2	1	3	4	2

25. 5 steps long values range (2, 1, 3, 4, 2) as it is for its reach at its middle from both end points will brings us face to face with the pair of strings of 3 steps each as:

$$(i)(2, 1, 3) \quad \text{and} \quad (ii) (3, 4, 2)$$

26. The first string (2, 1, 3) as such is the re-organization of triple value (1, 2, 3) such that the first phase value (1) gets placement at the middle.

27. Likewise, the second string (3, 4, 2), as well is re-organization of (4, 3, 2) which for its value (4) settles the placement at the middle.

28. It is this organization feature which deserves to be comprehended well for its complete imbibe and full appreciation for the fixation of the middle as of 3rd step, with first step as fixation of first end point and second step being the fixation of second end point and it is there after at third step is going to be the fixation of the middle placement of settled pair of end points.

29. Let us have a pause here and pause to our self as to need and justification for quadruple value (1, 2, 3, 4) to have extension as (1, 2, 3, 4, 2), as the end reach for linear order value (1) up-till its reach at value 4 (as 4-space of spatial order) and hence fourth there being the play of spatial order.

30. Further, the value 1, 2, 3, 4, 2, making it as (2, 1, 3, 4, 2). And then, as (2, 1, 3, 2, 4) as is the end composition form of formulation Shruti where in second vowel (ऌ) gets placement

not as the end placement but the placement prior to the end placement of the only consonant (ॠ) of this composition.

31. This inward reach and the inward progression from linear order to spatial order with origin getting placement with in the domain is the organization format of Vedic system which make them of simultaneous outward and inward expansion.
32. It is this simultaneous inward and outward expansion which makes Vedic systems of unique potentiality.
33. One shall sit comfortably and to permit the transcending mind to revisit the set up of cube (as hyper cube 3 with 2-space in the role of boundary as well as in the role of spatial order of creative origin of hyper cube 3 as a four folds manifestation layer (1, 2, 3, 4).
34. Sadhakas fulfilled with intensity of urge to glimpse further and to imbibe further shall visit and revisit the set up of a 3 dimensional frame and the split phenomenon of a 3 dimensional frame into a pair of 3 dimensional frames of half dimensions.
35. One shall further glimpse and imbibe the features of synthesis of a three dimensional frame has of a pair of three dimensional frame of half dimensions.
36. It would further be blissful to glimpse and imbibe the values and features of the setup of a cube with a 3 dimensional frame of half dimensions imbedded in each of its eight corner points with inward orientation for all the dimensions of all the eight dimensional frames imbedded within eight corner points.

37. Further one shall glimpse and imbibe the organization format features of coordination of eight corner points of the cube as origin points of the respective three dimensional frames in terms of four internal diagonal of the cube passing through the centre of the cube.
38. Further one shall glimpse and imbibe diagonal as the translation path of the respective pair of 3 dimensional frame of half dimensions embedded in the corner points of the cube as end corner points of the respective diagonals
39. Further one shall glimpse and imbibe the phenomenon of a pair of three dimensional frame of half dimensions translating ahead from the corner points for their reach at the centre of the cube as middle point of the respective diagonal as translation path
40. Further, one shall glimpse and imbibe the unification and synthesis of the pair of three dimensional frame of half dimensions as a three dimensional frame of full dimension with centre of the cube as that origin of the 3 dimensional frame.
41. Further one shall glimpse and imbibe the centre of the cube as a seat of origin of 3 space and a seat of hyper cube 4, the representative regular body of 4-space as 4-space domain enveloped with solid boundary of 8 Component comprehends of the format and features of 8 octaves of 3-space and 8 sub cube of the cube.
42. Further one shall glimpse and imbibe centre of the cube as origin of 4-space as a seat of compactified origin of whole range of origins of whole range of hyper cubes as

- representative regular bodies of four and higher dimensional spaces.
43. It would be blissful to glimpse and reach at origin of 4-space compactified with origin of 3-space at centre of the cube itself.
 44. One shall sit comfortably and to permit the transcending mind to glimpse quadruple synthesized three dimensional frame together with the fifth 3 dimensional frame of cube with origin at the centre and they together making a solid dimensional frame of five solid dimensions of transcendental domain (5-space domain).
 45. The split of three dimensional frame into a pair of three dimensional frame of half dimensions with 4-space playing the role of common origin will bring us face to face with the format of values triple (3, 4, 3) as the format for with the format of processing format of value $3+4+3 = 10$ which as a dimension lead us to value 12 as domain and same is parallel to the transcendental code value of formulation (Shruti).
 46. One shall sit comfortably and to permit the transcending mind to glimpse and imbibe the value formulation shruti
 47. One shall sit comfortably and to permit the transcending mind to continuously remain in prolonged sitting of trans and to be face to face with formulation Rishi (ऋषि) which also is transcendental code value 12.
 48. It would be blissful exercise to tabulate formulation transcendental code value 12
 49. Such tabulation will have prominent entries of 'Shiv, Yog, Rishi, Shruti' (शिव, योग, ऋषि, श्रुती).

50. One shall sit comfortably and to permit the transcending mind to remain in prolonged sitting of trans and to fully imbibe the values and features of formulation of transcendental code value 12, which are going to be 2^{11} in number
51. Value $2^{11} = 2048 = 2024+24$ is parallel to 2024 vargas organization of the text of 432000 Akshras of Shakala Rig Ved Samhita and value 24 is parallel to 24 double digit numbers of 5 place value systems accepting format of 4x6 grid with 25 has Anubandh of this set up.
52. It would be blissful to take note that $25 = 2 \times 12 + 1$ Parallel to 25 geometries range of hyper cube 12 with 25 versions of hyper cube 12 as the representative regular bodies of 25 geometries of 25-space.
53. It would be a very blissful exercise to tabulation formulation of transcendental code value 25 of which the prominent entries would be Vishnu (विष्णु), shrutih (श्रुतिः), Prithivi (पृथ्वी), Bhumi (भूमि), Bhuma (भूमा), Budhi (बुद्धि) and Dukha (दुःख)



5

FORMULATION

DHRISHTA (दृष्टा)

1. Formulation (दृष्टा) dhrishta accepts transcendental code value (21) which is parallel to transcendental code value 21 of formulation Gyan (ज्ञान).
2. Formulation (दृष्टा) Dhrishta avails five letter of transcendental code values range (6, 4, 6, 3, 2).

(दृष्टा) Dhrishta

$$(6+4+6+3+2 = 21)$$

द्	ऋ	ष्	ट्	आ
6	4	6	3	2

3. One may have a pause here and take note that value 21 accepts re-organization as $21 = 1+2+3+4+5+6$, which is parallel to values range format (1, 2, 3, 4, 5, 6) for Sathapatya measuring rod synthesized by hyper cubes 1 to 6 as representative regular body of 1 to 6-space for swapping 6-space domain as domain fold of hyper cube 6.
4. One shall further have a pause here and take note that scriptures preserve the enlightenment as that Rishi (ऋषि) Seer) as Dhrishta (दृष्टा) observer.
5. Formulation Rishi accepts TCV value 12.
6. Formulation Dhrishta accepts transcendental code value (21).

7. One may have a pause here and take note that values pair (12, 21) constitute a reflection pair (12, 11, 21) as here in this pair of values the pair of digits (1, 2) swap their places.
8. It is this feature of swapping orientations is the value which deserves to be comprehended well for its complete appreciation.
9. One may have a pause here and take note that interval (1-space body / line) accepts an organization of superimposed pair of orientations. To observer properly the distinctive features of opposite orientations and to decipherer them along the format of interval, is the value and virtue which is pojested by seers / Rishi (ऋषि).
10. One may have a pause here and take note that an organization of twenty one points is the organization of twenty gaps.
11. The transcendence through these gaps is of role of Ushamana letters.
12. One may have a pause here and to take note that quadruple Ushamane letter (श स ष ह) lead to quadruple values (2, 3, 6, 9) as transcendental code values of the Ushamana (उषमणः) letters.
13. One may further have a pause here and take note that value quadruple (2, 3, 6, 9) lead to summation value $2+3+6+9 = 20$, which is parallel to transcendental code value of formulation Dev (देव) as well as of formulation Ved (वेद).
14. Sadhakas fulfilled with intensity of urge further to acquire further insight to about the organization format of quadruple

- ushamana letters (श स् ष ह) of transcendental code value quadruple (2, 3, 6, 9) shall sequentially approach them.
15. First ushmana letter (श) is of transcendental code value (2).
 16. Value 2 is parallel to 2-space format.
 17. 2-space play the role of dimension of 4-space.
 18. 4-space plays the role of origin of 3-space
 19. As such, transcendence within origin is to be of spatial order and it is going to be of reach within 3-space domain.
 20. One may have a pause here and to permit the transcending mind to comprehend these values and features of transcendence from within origin of 3-space / centre of cube and being of reach within 3-space domain.
 21. It is going to be a reach from value 2 to value 3.
 22. First ushmana (श) letter accepts transcendental code value 2.
 23. Second ushmana (स्) letter accepts transcendental code value 3.
 24. One may further have a pause here and take note that the transcendence from within origin of 3-space / centre of cube is of spatial order and its reach through 3-space domain is uptill spatial boundary of 6 Components.
 25. It is this reach and attainment uptill spatial boundary of 6 Components bring us face to face with the transcendental code value 6 of third ushmana letter (ष).
 26. One may have a pause here and take note that the script form of third ushmana letter (ष), as it is, of the format of a half rectangle.

27. One may have a pause here and take note that 3-space plays the role of origin of 2-space.
28. 3-space origin transcendence out of 2-space domain and as a result 2-space domain splits into two parts and as a result manifests transcendence format (2, 3, 2).
29. One may have a pause here and take note that, as a result cube representative regular body of (3-space in the role of origin of 2-space) splits into a pair of prisms.
30. One shall sit comfortably and to permit the transcending mind to continuously remain in prolonged sitting of trans and to glimpse split of cube into a pair of prism and at their middle being a release of 4-space of spatial order.
31. One may have a pause here and take note that 4-space is of 9 geometries range parallel to which manifest 9 versions of hyper cube 4 being representative regular body of 9 geometries and value 9 is parallel to transcendental code value 9 of fourth ushamana letters (६).
32. Sadhakas fulfilled with intensity of urge to acquire further insight and to attain further enlightenment shall permit the transcending mind to glimpse and acquire values and features of formulation Tarak Rishi (तर्क ऋषि) and Tattav Gyan (तत्त्व ज्ञान).
33. Formulation Tarak (तर्क) is of transcendental code value 9.
34. However, its organization as it is of quadruple transcendental code values (4, 1, 1, 2).
35. One may have a pause here and take note that triple linear order dimension synthesis value $6 = (1, 1, 1)$.

36. With it, the values range (4, 1, 1, 2) becomes the values range (4, 6, 2) which is parallel to values and organization formation of formulation Rishi (ऋषि).
37. One shall sit comfortably and to permit the transcending mind to glimpse and imbibe fully comprehend and complete appreciation.
38. Sadhakas shall revisit formulation Tattav (तत्त्व).
39. Formulation Tattav (तत्त्व) is a composition of seven letters of values range (4, 1, 4, 4, 1, 7, 1) of summation value $(4+1+4+4+1+7+1 = 21)$ which is parallel to transcendental code value of formulation Gyan (ज्ञान).
40. One shall sit comfortably and to permit the transcending mind to glimpse and imbibe above values and features to acquire proper insight and to attain appropriate enlightenment about Vedic formulations Dhristha (दृष्टा), Rishi (ऋषि), Tarak (), Tattav (तत्त्व) and Gyan (ज्ञान) by properly glimpsing and imbibing the value and formats of Ushamana letters.



देवनागरीं वर्णमाला

Nine vowels स्वराः

अ इ उ ऋ ल् ए ओ ऐ औ

। ˆ ˆ ˆ ˆ ˆ ˆ ˆ ˆ

1 2 3 4 5 6 7 8 9

5 x 5 Varga consonants वर्गाः

कावर्ग (कु)

क् ख् ग् ध् ङ्

1 2 3 4 5

चावर्ग (चु)

च् छ् ज् झ् ज्ञ्

2 3 4 5 6

टावर्ग (टु)

ट् ठ् ड् ढ् ण्

3 4 5 6 7

तावर्ग (तु)

त् थ् द् ध् न्

4 5 6 7 8

पावर्ग (पु)

प् फ् ब् भ् म्

5 6 7 8 9

Anthstha letters: अन्तस्था

य् र् ल् व्

1 3 5 7

Ushmana letters: उषमणः

श् स् ष् ह्

2 3 6 9

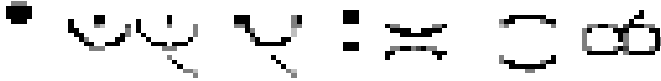
Yama letters यामा

9 10 11 12 13 14 15 16



6

LETTER BY LETTER CHASE

1. Sadhakas fulfilled with intensity of urge to glimpse and imbibe the values and virtues of organization format of the texts of vedic scripture shall permit the transcending mind to glimpse and imbibe the manifestation of individual letters and there coordination inter-see while being availed for compositions of words of the Text.
2. The first feature is the manifestation of the letters themselves.
3. The second feature is there coordination inter-see within the alphabet format of whole range of letters.
4. The next aspect is of inter-see coordination of the letters availed for composition of a word.
5. As for as the first aspect of manifestation of letters themselves is concerned, the same brings us face to face with the central feature and value of vedic systems, as that the beginning and end is to be at the samement like that of every point of the circumference, as the starting point, as well as the end reach point after full chase of the complete format of the circumference.
6. With it, letters becomes the point values, and alphabet format emerges to be the set up of the circumference itself as the format of alphabet of the letters.
7. Alphabet as the starting position, as well as the end reach, as such makes its as that to known fully about alphabet would

- mean to know completely about the reach interms of the alphabet letters
8. One may have a pause here and to permit the transcending mind to continuously remain in prolonged sitting of trans to glimpse and imbibe values and virtues of vedic knowledge as devnagri alphabet being its initiation as well as the ultimate attainment.
 9. Devnagri alphabet as the initiation, as well as the ultimate attainment, as the first virtue of Vedic system, further bring us face to face with the feature and value of organization of devnagri alphabet letters in a sequential frame of the format of cyclic set up of the circumference.
 10. One may have a pause here and to permit the transcending mind to glimpse and imbibe the set ups and format of circumference as a set up for accommodating the set up of a line superimposed for its transition and transformation as a set up of a circumference.
 11. It is this inherent value of the linear set up as of potentiality to transit and transform parallel to the cyclic set up of circumference, which deserves to be comprehended well for its complete imbibing for full appreciation and for acquiring appropriate insight, as well as for attaining appropriate enlightenment about letters of the alphabet.
 12. Letters as point, make range of 50 points as 50 letters of devnagri alphabet.
 13. Number value 50 with its organization $50 = 5 \times 10$ makes it parallel to 50 coordinates requirement for coordination of creative boundary (4-space as boundary) of 10 Components

- of the transcendental domain (5-space domain) within a solid dimensional (3-space as dimension) frame of 5 dimensions.
14. Further value 50 also brings us face to face with the set up of a right angle triangle (3, 4, 5) of value and feature ($3^2 + 4^2 = 5^2$) and $3^2+4^2+5^2 = 50$.
 15. It would be a blissful exercise to comprehend and imbibe the values of expression $(N-1)^2 + N^2 = (N+1)^2 = 3N^2+2$. Which for $N = 3$ comes to be '29'.
 16. Further, $N^2+(N+1)^2 + (N+2)^2 = 3N^2+6N+5$ for $N = 3$ comes to be '50'.
 17. And, $(N-2)^2 + (N-1)^2 +N^2 = 3N^2 - 6N+5$, for $N = 3$, comes to be 14.
 18. Like that, triple consecutive numbers (1, 2, 3), (2, 3, 4) and (3, 4, 5) with (3) as one of the value leads to triple-triple square set ups $1^2+2^2+3^2 = 14$, $2^2+3^2 +4^2 = 29$, $3^2 +4^2+5^2 = 50$.
 19. One may have a pause here and take note that value 14 accepts re-organization as $14 = 2+3+4+5$, which is parallel to four folds manifestation layer (2, 3, 4, 5) of hyper cube 4, the representative regular body of 4-space, within 4-space presided by Lord Brahma.
 20. Value 29 is the fourth split value of domains split spectrum range (1, 2, 5, 12, 29, 70, ...) and this value (29) is parallel to transcendental code value of formulation Brahma (ब्रह्मा).
 21. Value 50 accepts organization as $50 = 11+12+13+14$, which is parallel to four folds manifestation layer (11, 12, 13, 14) of hyper cube 13.

22. One may have a pause here and take note that 5-space as origin of 4-space, transcends out and creates a transcendence values triple (4, 5, 4) for the split of 4-space domain into a pair of 4-space domain.
23. One may have a pause here and take note that values triple (4, 5, 4) is of summation value ($4+5+4=13$).
24. Value 4 is parallel to 4-space.
25. Value 5 is parallel to 5-space.
26. 4-space plays the role of boundary of 5-space.
27. The boundary of 5-space is a set up of ten Components and remains coordinated with transcendental domain in terms of $10 \times 5 = 50$ coordinates of five dimensional frame of 5-space.
28. One shall sit comfortably and to permit the transcending mind to glimpse and imbibe above feature
29. It would be blissful exercise to visit the format value and feature of first letter (अ).
30. It is (वर्ण) varan / letter.
31. It is (स्वरा) Swara / vowel.
32. It is (अक्षर) Akshara / syllable.
33. It is (गुण) Guna / structural features.
34. It is (अकारा) Akara/
35. One may have a pause here and take note that TCV (वर्ण) = 18, TCV (स्वरा) = 15, TCV (अक्षर) = 13 and TCV (गुण) = 14, TCV (अकारा) = 8
36. It would further be blissful to take note that script form of letter (अ) is of the format and feature of cube placed upon

four legged table parallel to solid boundary Component of 4-space.

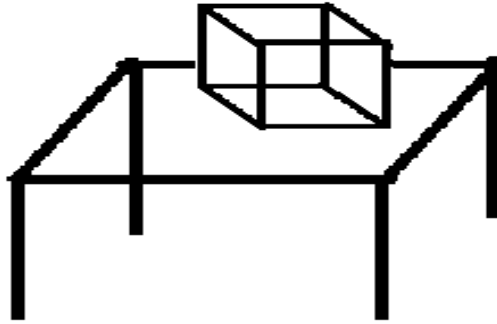

37. It would further be blissful to visit and revisit 18 formulations expressions of first of letter (37).

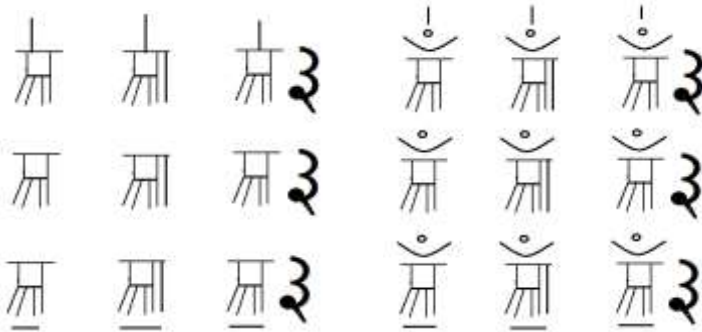
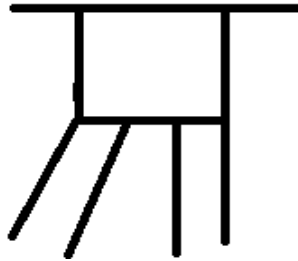

38. Sadhakas fulfilled with intensity of urge to glimpse and imbibe the vedic processing systems coordination of different letters being availed for formation of words composition shall also glimpse through the formulation expression and script form of other letter of devnagri alphabet as well.
39. Further, one shall also glimpse and imbibe the values and features of devnagri alphabet and way its letters are coordinated as per their placement within the alphabet and the way, as per the placement, letters acquire values.
40. Further, one shall also reach at the parallel geometric format for the respective value of the individual letters.
41. Like that, one shall sequentially reach at the interrelationship of values and geometric format.
42. A step ahead, one shall glimpse and imbibe the parallel values and features of sankhiya nishta and yoga nishta.
43. Sankhiya nishta presumes the existence of geometric format and avails artifices of numbers.
44. Yoga nishta presumes the existence of artifices of number and avails dimensional frames of geometric domains.
45. Sadhakas fulfilled with intensity of urge to acquire proper insight and to attain appropriate enlightenment about vedic systems as composed text availing devnagri alphabet format shall fully glimpse and to completely imbibe the value and features of Sathapatya measuring rod synthesized by hyper cubes 1 to 9 as representative regular body of 1 to 9-space.
46. It is comprehension of parallel formats of values 1 to 9 and of hyper cubes 1 to 9 which shall be ensuring proper insight and appropriate enlightenment about the organization as well

- as the processing steps of vedic systems and vedic knowledge.
47. One may begin with value 1 and hyper cube 1 (interval) to have proper appreciation for their parallel values and features, and sequentially one shall reach at comprehension of parallel feature of (2 and hyper cube 2 (square), '3' and hyper cube 3 / cube', and so on, uptill '9' and hyper cube 9'.
 48. One may have a pause here and take note that ten place value systems has 9 numerals range of values (1, 2, 3, 4, 5, 6, 7, 8 ,9).
 49. Further as that, hyper cube 9 as 9 versions. The creative boundary of transcendental domain (5-space) is of ten components.
 50. It would be blissful to comprehend and imbibe creative boundary of transcendental domain as a format for ten place value system.
 51. With it, the transcendence from manifestation creation format of 4 folds to the set ups of transcendence ranges will be a reach of the Vedic systems attaining simultaneous attainment of transition from Mool Ank (मूल अंक) (numerals values 1 to 9) to Divya Ank Vyashta (दिव्य अंक व्यवस्था) of values range 1 to 16.
 52. One may have a pause here and take note that formulation Dhatu (धातु) is of transcendental code value $16 = 9+7 = TCV$ (dha)(धा)+ TCV (tu)(तु).
 53. Formulation Shabd (शब्द) is of transcendental code value $17 = 9+8$ parallel to 9 points range leading to eight gaps.

54. One shall sit comfortably and to permit the transcending mind to glimpse and to imbibe Divya Ank Vyashta (दिव्य अंक व्यवस्था).



**VEDIC MATHEMATICS OF EXISTENCE
PHENOMENON**

CONTENT

5. Vedic Mathematics of existence phenomenon
6. Self referral organization format
7. Swapping self referral domain
8. Number value 18

VEDIC MATHEMATICS OF EXISTENCE PHENOMENON

1. Sadhakas fulfilled with intensity of urge to glimpse and imbibe the values and features of Vedic Mathematics of existence phenomenon shall imbibe the values and features of following 32 scriptures.

(i) Rig Ved ऋग्वेद (ii) Yajur Ved यजुर्वेद (iii) Sam Ved समवेद (iv) Athrav Ved अथर्ववेद (v) Ayur upved आयुर्वेद (vi) Dhanur upved धनुर्वेद (vii) Ghandharav upved गन्धर्व वेद (viii) Sathapatya upved स्थापत्य वेद (ix) Shiksha शिक्षा (x) Vyakaran व्याकरण (xi) Nirukt निरुक्त (Xii) Chandas छन्दस् (Xiii) Jyotish ज्योतिष् (xiv) Kalp कल्प (Xv) Sankhiya darshan सांख्यदर्शन (xvi) Yoga darshan योगदर्शन (Xvii) Nyaya darshan न्याय दर्शन (xviii) Vasahik darshan वैशेषिकदर्शन (Xix) Purv Mimansa darshan पूर्वमीमांसादर्शन (xx) Baramsutar / uttar mimansha darshan / vedanta ब्रह्मसूत्र / उत्तरमीमांसादर्शन वेदान्त (Xxi) Isha ईशः उपनिषदः (Xxii) Mandaky माण्डूक्योपनिषद् (Xxiii) Mundka मुण्डकोपनिषद् (Xxiv) Kein केने उपनिषदः (Xxv) Katho कठो उपनिषदः (Xxvi) Parshno प्रश्नोपनिषदः (Xxvii) Tatriya

तैत्तरयोपनिषद् (Xxviii) Atriya ऐतरयोपनिषद् (XXix)
 Swateshwara श्वतेश्वरोपनिषदः (Xxx) Chhandago
 छन्दोग्योपनिषद् (Xxxi) Bridharyank बृहदराण्यका
 उपनिषदः (Xxxii) Sri mad Bhagwad Geeta गीता

2. Chase of Existence phenomenon of Pursha format parallel to format and feature of Solar Universe is in-terms of format and features of Sathapatya measuring rod synthesized as of hyper cubes 1 to 6, representative regular bodies of 1 to 6-space, with lord Vishnu being presiding deity of this measuring rod and lord Brahma being the presiding deity of the measuring of this measuring rod. The transcendental flow along this measuring rod is of the format of Vashuki Nag availing the format state of transcendental lord Shiv. Transcendental format state is the transcendental creation base upon which manifests Vedic alphabet of Devnagri script form.
3. Sadhakas fulfilled with intensity of urge to glimpse and imbibe the values and features of Vedic Mathematics as mathematics of chase steps of Vedic systems for chase of existence phenomenon within human frame as of order of solar universe permit the transcending mind to continuously remain in prolonged sitting of trans and to glimpse and imbibe parallel format feature and value of shad chakra format of human frame and of Sathapatya measuring rod, as well as of the Panch Maha Bhut (Earth, Water, fire, Air, Space) permitting transcendence and reach to Surya.

4. Surya, as 6-space body, is of creative dimensional order. And is the existence phenomenon within a dimensional frame of 6 creative dimensions. Hyper cubes as a representative regular body of dimensional spaces within 4-space along the format of idol of Lord Brahma, are four folds manifestation layer of dimension, boundary, domain and origin folds along the transcendental base (5-space base) of self referral format (6-space format).
5. One may have a pause here and take note that hyper cube 5 as four folds manifestation layer (3, 4, 5, 6) is of self referral origin (6-space as origin) of 5-space) and the transcendental phenomenon of transcendence of self referral origin splits the transcendental domain into a pair of transcendental domain and makes a transcendence format (5, 6, 5) of summation value $5+6+5 = 16$, which is of organization $16 = 2^4$ parallel to the spatial dimensional frame of quadruple dimension of creator' space (4-space).
6. This leads to transcendental values for Devnagri Alphabet format as of range 1 to 16.

देवनागरीं वर्णमाला

Nine vowels स्वरः

अ इ उ ऋ लृ ए ओ ऐ औ

। ˆ ७ ८ ˆ ो ै ौ

1 2 3 4 5 6 7 8 9

5 x 5 Varga consonants वर्गाः

कवर्ग (कु)

क् ख् ग् ध् झ्

1 2 3 4 5

चवर्ग (चु)

च् छ् ज् झ् ञ्

2 3 4 5 6

टवर्ग (टु)

ट् ठ् ड् ढ् ण्

3 4 5 6 7

तवर्ग (तु)

त् थ् द् ध् न्

4 5 6 7 8

पवर्ग (पु)

प् फ् ब् भ् म्

5 6 7 8 9

Anthstha letters: अन्तस्थ

य् र् ल् व्

1 3 5 7

Ushmana letters: उष्मणः

श् स् ष् ह्

2 3 6 9

Yama letters यमः

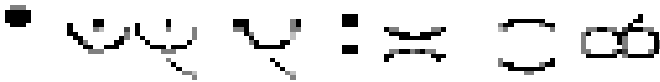

9 10 11 12 13 14 15 16

7. One may have a pause here and take note that frequency of value 5 of choices from the range (1, 2, 3, 4, 5) is '16':
 (i) $5 = 5$, (ii) $5 = 1+4$, (iii) $5 = 4+1$, (iv) $5 = 1+1+3$,
 (v) $5 = 1+3+1$, (vi) $5 = 3+1+1$, (vii) $5 = 2+3$,
 (viii) $5 = 3+2$, (ix) $5 = 1+2+2$, (x) $5 = 2+1+2$,
 (xi) $5 = 2+2+1$, (xii) $5 = 1+1+1+2$,
 (xiii) $5 = 1+1+2+1$, (xiv) $5 = 1+2+1+1$,
 (xv) $5 = 2+1+1+1$, (xvi) $5 = 1+1+1+1+1$
8. Sadhakas fulfilled with intensity of urge to glimpse and imbibe the format and features of Vedic Mathematics systems for chase of existence phenomenon as is preserved in the Vedic scripture shall comprehend and imbibe the transcendental code values of word formulation availing Devnagri alphabet letters as the summation value of the individual transcendental code value of the letters of the word so composed.
9. Word formulation Ved (वेद) accepts association of transcendental code value '20'.

Ved (वेद)
 $(7+6+6+1 = 20)$

व्	ए	द्	ट
7	6	6	1

10. It would be a blissful exercise to reach at transcendental code value for the following word formulations.

S.	Word Formulation	TCV
----	------------------	-----

No		
1	ऋग्वेद	7+20 = 27
2	यजुर्वेद	11+20 = 31
3	समवेद	15+20 = 35
4	तथर्ववेद	17+20 = 37
5	आर्यु उपवेद	8+29 = 37
6	धर्नु उपवेद	21+29 = 50
7	गन्धर्व उपवेद	30+29 = 59
8	स्थापत्य उपवेद	22+29 = 51
9	शिक्षा उपाअंग	13+19 = 32
10	व्याकरण उपाअंग	24+19 = 43
11	निरूक्त उपाअंग	25+19 = 44
12	छन्दस् उपाअंग	22+19 = 41
13	ज्योतिष् उपाअंग	24+19 = 43
14	कल्प उपाअंग	13+19 = 32
15	सौख्यदर्शन	19+21 = 40
16	योगदर्शन	12+21 = 33
17	न्यायदर्शन	13+21 = 34
18	वैशेषिकदर्शन	33+21 = 54
19	पूर्वमीमांसादर्शन	21+36+21 = 78
20	ब्रह्मसूत्र / उत्तरमीमांसादर्शन / वेदान्त	43 /16+36+21 / 20+14
21	ईशः उपनिषदः	7+42 = 49
22	माण्डूक्योपनिषद्	27+42 = 69
23	मुण्डकोपनिषद्	28+42 = 70
24	केने उपनिषदः	16+42 = 58

25	कठो उपनिषदः	7+42 = 47
26	प्रश्नोपनिषदः	18+42 = 60
27	तैत्तरयोपनिषद्	23+42 = 65
28	ऐतरयोपनिषद्	22+42 = 64
29	श्वतेश्वरोपनिषदः	32+42 = 74
30	छन्दोग्योपनिषद्	24+42 = 64
31	बृहदराण्यका उपनिषदः	36+42 = 78
32	श्रीमद्भगवद्गीता	7+16+13+14+13 =63

11. It would further be a blissful exercise to chase shad Chakra of human frame for its external characteristics parallel to boundary Components of hyper cubes 1 to 6 as of values range (2, 4, 6, 8, 10, 12) as domain boundary ratios of hyper cubes are of formulation $A^N = B^{N-1}$.

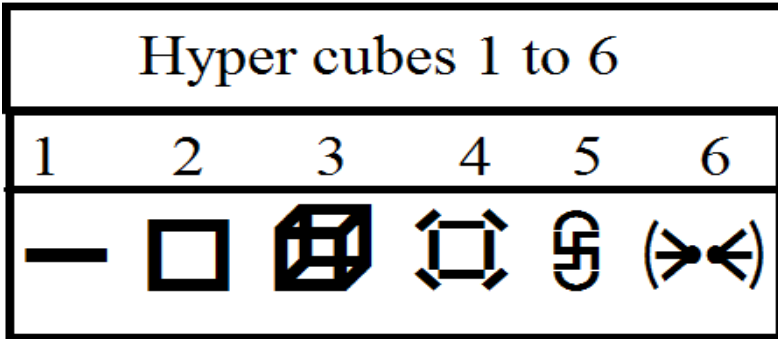

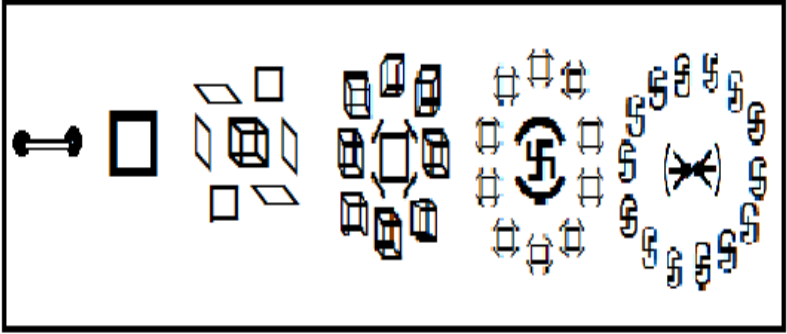

12. It would further be a blissful exercise to chase jyoti manifestation flow through orb of the Sun along artifices of sole syllable with Bindu Sarovar superimposed upon orb of the sun and jyoti flow through artifices of sole syllable om fulfilling pushpika with transcendental origin:

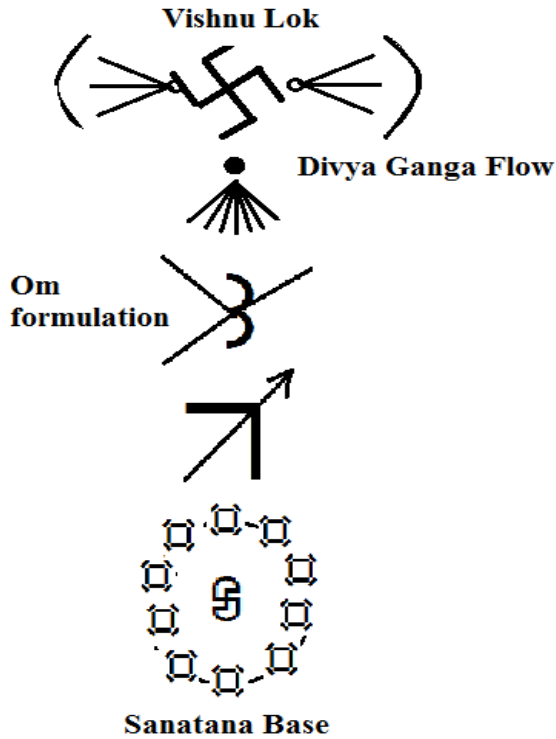

13. Sadhakas fulfilled with intensity of urge to chase the Vedic Mathematics for the steps of chase of existence phenomenon within human frame as of solar universal order shall initiate chase with Devnagri alphabet as per its transcendental code values along the format of Sathapatya measuring rod permitting transcendental flow of Jyoti availing the format of sole syllable Om of sequential value of Bindu Sarovar, Ardh Matra, Tri-Pundram and Swastik Pada permitting Jyoti flow of Brahman Reservoir of 7 streams, 3 streams and single stream of reach up-till the transcendental origin of Pushpika (creator's space) ■

2

SELF REFERRAL ORGANIZATION FORMAT

1. Vedic Mathematics is of self referral format for chase of existence phenomenon in its creative manifested form of transcendental base.
2. Creative manifested forms are of spatial dimensional order. Its transcendental origin is of solid dimensional order. And, self referral format of transcendental base of manifested creation is of creative dimensional order.
3. One may have a pause here and take note that the self referral format chase in terms of spatial dimensional order is of 6x6 grid format permitting expression as under:

1	2	3	4	5	6
2	3	4	5	6	7
3	4	5	6	7	8
4	5	6	7	8	9
5	6	7	8	9	10
6	7	8	9	10	11

4. And, chase of transcendental origin, in terms of spatial order, is a chase of 5x5 grid format, as of values organization expression.

1	2	3	4	5
---	---	---	---	---

2	3	4	5	6
3	4	5	6	7
4	5	6	7	8
5	6	7	8	9

5. And, creative manifested domain becomes a chase of value accommodated by 4x4 grid:

1	2	3	4
2	3	4	5
3	4	5	6
4	5	6	7

6. The spatial order itself, as such in the process under such chase features becomes a set up of values of format of 2x2 grid:

1	2
2	3

7. The solid order becomes of values organization accommodated by 3x3 grid.

1	2	3
2	3	4
3	4	5

8. 2-space in the role of dimension, as spatial order of 4-space, manifest spatial order dimensional frame of quadruple dimensions which makes a frame of value 2^4 .
9. Solid dimensional order manifests dimensional frame of 5 solid dimensions of transcendental domain and the same as such, is of value 3^5 .
10. 3-space itself being of a linear dimensional order making a solid unit value.
11. Creative dimensional order of self referral domain (6-space domain) manifests a dimensional frame of 6 creative dimensions making a set up of value 4^6 . However, as creative space (4-space) itself being of a spatial order, as such, creative dimension makes a hyper unit of value 2^4 .
12. One may have a pause here and take note that to permit the transcending mind to glimpse and imbibe distinctive values and features of creative domain (4-space) within spatial dimensional frame, transcendental domain (5-space) within solid dimensional frame and self referral domain within creative dimensional frame.
13. The creative domain accepts a measuring rod synthesized by hyper cubes 1, 2, 3 and 4 and same envelops a creative boundary of transcendental domain (as origin of creator's space).
14. Transcendental domain accepts measuring rod synthesized by hyper cubes 1 to 5 which reaches uptill transcendental boundary (5-space as boundary of self referral domain (6-space domain as origin of 5-space domain).

15. Self referral domain (6-space domain) gets surfacing in terms of Sathapatya measuring rod synthesized by hyper cubes 1 to 6 which reach uptill self referral boundary (6-space as boundary of unity state domain (7-space domain) in the role of origin of 6-space domain).
16. One may have a pause here and take note that Sathapatya measuring rod chase as self referral boundary (6-space as boundary of unity state domain (7-space domain) is of format and feature of self referral boundary being of 14 Components.
17. One may have a pause here and take note that domain boundary ratio of hyper cube 7, is $A^7:14B^6$.
18. The spatial order with '2' as '1' makes chase of value '14' as of unit '7'.
19. One may have a pause here and take note that formulation Sapt (सप्त) of simple rendering as value '7', accepts transcendental code value '14'.

Sapt (सप्त)

$$(3+1+4+5+1 = 14)$$

स्	अ	प्	त्	अ
3	1	4	5	1

20. Formulation (सप्त) Sapt is a set up of a pair of syllables (i) (स), (ii) (प्त), as of transcendental code value pair (4, 10).

21. One may have a pause here and take note that value '4' is of organization $(4) = 1+1+1+1$, and value (10) is of organization $10 = 1+2+3+4$.
22. One may have a pause here and to permit the transcending mind to glimpse and imbibe this pair of organizations $[(1+1+1+1)$ and $(1+2+3+4)]$, being affine and sequential progressions simultaneously available in the set up of word formulation (सप्त) Sapt.
23. One may have a pause here and take note that a step ahead, the solid order of the transcendental domain (5-space domain) shall be bringing us face to face with formulation (पंच) Panch as rendering of value (5) accepts transcendental code value (15).
24. It would be blissful to take note that five steps long affine values range $(1+1+1+1+1) = 5$ leads us to five steps long sequential progression $(1+2+3+4+5) = 15$.
25. Sadhakas fulfilled with intensity of urge to glimpse and imbibe the format and feature of linear, spatial, solid, creative and creative dimensional orders shall chase the simple value rendering as well as transcendental code values of following quantifiers parallel to numerals 1 to 9 of ten place value systems.

S. No	Formulation	Simple Rendering	TCV
1	एक		8
2	द्वय		16

3	त्रय		8
4	चर्तु		12
5	पच्च		15
6	षट्		10
7	सप्त		14
8	अष्ट		11
9	नव		17
10	दश		10

26. One shall sit comfortably and to permit the transcending mind to continuously remain in prolonged sitting of trans and to glimpse and imbibe above formulation.



SWAPING SELF REFERRAL DOMAIN

1. Vedic systems swap self referral domain (6-space domain) with Sathapatya measuring rod.
2. Sathapatya measuring rod is a synthetic set up of hyper cubes 1 to 6 manifesting as four folds manifestation layers within creator's space (4-space) along the format of Idol of Lord Brahma, four head lord with a pair of eyes in each head and t

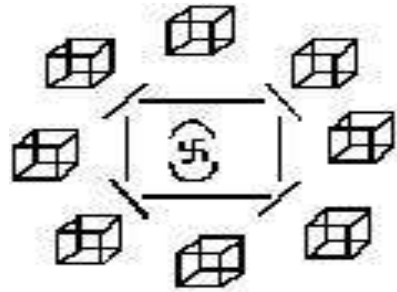

ing a seat of transcendental lord within the cavity of heart of Lord Brahma.

Lord Brahma sit gracefully on the lotus seat of eight petals and with grace of transcendental, lord Brahmas multiplies as ten brahmas.



3. Sathapatya measuring rod as a set up of hyper cubes 1 to 6 makes a set up of 6 four folds manifestation layers:
- (i) (-1, 0, 1, 2), (ii) (0, 1, 2, 3), (iii) (1, 2, 3, 4), (iv) 2, 3, 4, 5, (v) 3, 4, 5, 6, (vi) 4, 5, 6, 7.
- (i) This as such is parallel to set up of a dimensional frame, $6 \times 4 = 24$ constituents parallel to creative dimensional frame of self referral domain itself.
4. Set up of six quadruple folds manifestation layers comes to be parallel to accommodated 24 double digit numbers of 5 place value systems within 4×6 grid.

01	02	03	04
02	03	04	05
03	04	05	06
04	05	06	07
05	06	07	08
06	07	08	09

- One shall sit comfortably and to permit the transcending mind to glimpse and imbibe these formats and features.

FIRST FEATURE

- The first feature to be imbibed is the set up of Sathapatya measuring rod as of hyper cubes 1 to 6.

Hyper cubes 1 to 6					
1	2	3	4	5	6
—	□	⊠	⊞	卐	(→←)

SECOND FEATURE

- The second feature to be imbibed of the set ups is the domain boundary ratios of hyper cubes 1 to 6 as per the formulation $A^N:2NB^{N-1}$, $N = 1, 2, 3, 4, 5, 6$.

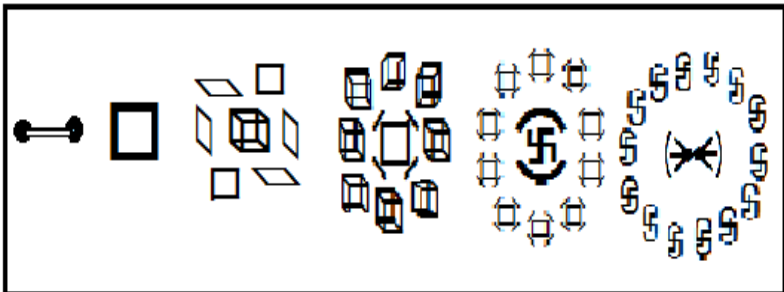

THIRD FEATURE

8. Third feature to be imbibed is the (negative, zero, linear, spatial, solid and creative dimensional orders) of hyper cubes 1 to 6 which lead to the set ups of:

Hyper cube-1 dimensional frame

- (i) Hyper cube -1 is of dimensional frame of single dimension of negative linear order.

Hyper cube-2 dimensional frame

- (ii) Hyper cube-2 dimensional frame is a set up of two dimensional of zero order.

Hyper cube -3 dimensional frame

- (iii) Hyper cube-3 dimensional frame is a set up of 3 dimensions of linear order.

Hyper cube-4 dimensional frame

- (iv) Hyper cube -4 dimensional frames is a set up of quadruple dimensions of spatial order.

Hyper cube-5 dimensional frame

- (v) Hyper cube -5 dimensional frames is a set up of penta dimensions of solid order.

Hyper cube-6 dimensional frame

- (vi) Hyper cube-6 dimensional frame is a set up of hexa dimension of creative order.

FOURTH FEATURE

9. Fourth feature to be imbibed is about the pair of values generated by the dimensional frames.

Four space dimensional frame

- (i) Hyper cube 4 with its creative dimensional frame of quadruple dimensions leads to values pair :
- (a) $2+2+2+2 = 8$
 (b) $2 \times 2 \times 2 \times 2 = 16$
- (ii) One may have a pause here and take note that :
- (a) TCV (एक) EK = 8, and (b) TCV (द्वय) Dwaya = 16.
- (iii) One may further have a pause here and take note that:
- (a) $1+2+3+4 = 10$ and,
 (b) $1 \times 2 \times 3 \times 4 = 24$.
- (iv) It would be blissful to take note that (a) $10 = 4+6$, and
 (b) $24 = 4 \times 6$.
- (v) It would further be blissful to take note that $(4+6)+(4 \times 6) = 34 = 7+8+9+10$, which is parallel to four folds manifestation layers (7, 8, 9, 10) of hyper cube 9.
- (vi) It would further be blissful to take note that hyper cube 4 is of nine versions parallel to representative regular geometric bodies of 9 geometries of 4-space.

Five space dimensional frame

- (i) 5-space is a solid dimensional order and its dimensional frame is a set up of 5 solid dimensions.
- (ii) (a) $(3+3+3+3+3) = 15$, and (b) $3 \times 3 \times 3 \times 3 \times 3 = 243$.
- (iii) One may have a pause here and take note that $(1+1+1+1) = 10$, and $(1+2+3+4) = 10$
- (iv) Further, $1+1+1+1+1 = 5$ and $1+2+3+4+5 = 15$
- (v) One may have a pause here and take note that formulation Panch has simple rendering value (5) and transcendental code value (15).
- (vi) Further, $(1+2+3+4+5) = 15$, and $(1 \times 2 \times 3 \times 4 \times 5) = 120$
- (vii) One may have a pause here and take note that value 243 brings us face to face with transcendental triple (2, 3, 4) which is parallel to the spatial, solid and creative dimensional order of 4, 5, 6 space respectively.
- (viii) Further the placement of value (4), in between values pairs (2, 3) is the solid order feature which bring in higher value at the middle, parallel to sequential fixation of pair of end points and it is only after fixation of pair of end points, reach is to be had at the middle placement for the end pair of value.

Six space dimensional frame

- (i) 6-space dimensional frame is a set up of hexa creative dimension.
- (ii) Further $(4+4+4+4+4+4) = 24$, and $(4 \times 4 \times 4 \times 4 \times 4 \times 4) = 4096$.

FIFTH FEATURE

10. Fifth feature is to be imbibed is of the existence phenomenon of 6-space domain within 6-space domain.
11. And, further, re-manifestation of 6-space content along the formats of hyper cubes 1 to 6.
12. One shall sit comfortably and to glimpse and imbibe the phenomenon of manifestation of dimensional space content along the individual format of hyper cube, as well as along the format of Sathapatya measuring rod of different dimensional spaces.
13. Further, it would be blissful to glimpse manifestation of 6-space content along the sequential format of Sathapatya measuring rod as a synthetic set up of hyper cubes 1 to 6.

SIXTH FEATURE

14. Six feature is to be imbibed is of re-manifestation phenomenon which is of the format and features as follows:
 - (i) Hyper cube 5 is a four folds manifestation layer (3, 4, 5, 6).
 - (ii) Summation value of 4 folds manifestation layer (3, 4, 5, 6) is 18.
 - (iii) Hyper cube 17 is a four folds manifestation layers (15, 16, 17, 18) with 18-space playing the role of origin fold.
 - (iv) One may have a pause here and take note that 4 folds manifestation layers (16, 17, 18, 19) leads to summation value $(15+16+17+18 = 67)$.

- (v) One may have a pause here and take note that 66-space plays the role of origin fold of hyper cube 65.
- (vi) Hyper cube 65 is a four folds manifestation layer (63, 64, 65, 66) which leads to summation value $63+64+65+66 = 229$.
- (vii) One may have a pause here and take note that value 63 accepts organization as $63 = 7 \times 9$.
- (viii) It would be blissful to take note value (-79) is parallel to synthesis value of a pair of transcendence ranges of order (-9).
- (ix) It would further be blissful to take note that the synthesis values range of order (-9) to order (7) is a set up of 17 steps values range:
 $(-79, -68, -57, -46, -35, -24, -13, -2, 9)$
 $(97, 86, 75, 64, 53, 42, 31, 20)$
- (x) One shall sit comfortably and to permit the transcending mind to glimpse and imbibe above reach for the format of hyper cube 5 to the format of hyper cube 17 and uptill the range of 7 steps long synthesis values range of pair of transcendence range of order (-9) to (7).

SEVEN FEATURE

15. Seventh feature to be imbibed is of the format and features of Divya Ganga Parvaha along the artifices of Components of sole syllable om:

- (i) Sole syllable om is a set up of four Components (Bindu Sarovar, Ardh Matra, Tri-Pundram and Swastik Pada).
- (ii) These Components are of artifices values quadruple (9, 7, 3, 1).
- (iii) Divya ganga parvaha is from bindu sarovar of placement at orb of the sun as Brahman domain (value 9 / 9-space / Nav Braham).
- (iv) Value 9 accepts organization as $9 = 3 \times 3$.
- (v) Value 3×3 is parallel to a spatial set up of $3 \times 3 = 9$ units.
- (vi) Spatial set up is of solid origin (3-space plays the role of origin of 2-space).
- (vii) 3-space is of 7 geometries range with 7 versions of hyper cube 3 as of the format of representative regular body of 7 geometry of 3-space
- (viii) This phenomenon is parallel to flow of 7 stream of Jyoti from the Bindu Sarovar of placement of Brahaman domain as origin.
- (ix) One may have a pause here and take note that 7-space plays the role of dimension of 9-space.
- (x) Further, -9-space plays the role of dimension of -7-space,
- (xi) 7 stream flow splits as a pair of 3 streams with seventh stream flow at the middle of the split.
- (xii) One may have a pause here and to glimpse and imbibe this flow from the centre of a square.

- (xiii) One may further have a pause here and take note that this flow is to be has of a flow from the centre of the surface to 9 unit area, and the same shall be making a solid set up of $9 \times 7 = 63$ units.
- (xiv) One may have a pause here and take note that value 63 accepts organization as $63 = 2 \times 31 + 1$, parallel to 63 versions of hyper cube 31.
- (xv) One may further have a pause here and take note that value 31 is parallel to 31 structural Components of cube (hyper cube 3): (8 corner points + 12 edges, + 6 surface + 1 volume + 3 dimensions + 1 centre).
- (xvi) Taking centre as a point of volume itself and so, as in a sealed state shall be making the set up of cube as of remaining 30 structural Components.
- (xvii) One may have a pause here and take note that centre of the cube is of a dual status, firstly as a point of the volume and secondly as origin which is of a spatial order, and that way centre of the cube will sequentially accepts values triple (0, 1, 2), while in a sealed state, further while as of linear expression because of first dimension of spatial order, and ahead because of spatial dimension in its integrated set up.
- (xviii) Sadhakas fulfilled with intensity of urge to glimpse and imbibe the self referral domain 6-space domain, shall glimpse it fully as the origin fold of transcendental domain of solid order.

EIGHT FEATURE

16. One shall sit comfortably and to permit the transcending mind to glimpse and imbibe the values and features of number value 30.
17. Number value 30 accepts eight divisors: (1, 2, 3, 5, 6, 10, 15, 30).
18. One may have a pause here and take note that 3-space accepts split as eight octant and parallel to it there is split of cube as eight sub cube.
19. It would further be blissful to take note that (i) $2 \times 2 \times 2 = 8 = 2 + 2 + 2 + 2$.
20. Further as that TCV (EK) = 8.
21. One shall further glimpse and imbibe the values and format of number value 60 which accepts 12 divisors: (1, 2, 3, 4, 5, 6, 10, 12, 15, 20, 30, 60).
22. One may have a pause here and take note that TCV (Chatur) = 12.
23. One shall further glimpse and imbibe the format and values of 120, which accepts 15 divisors (1, 2, 3, 4, 5, 6, 8, 10, 12, 15, 20, 24, 30, 60, 120).
24. It would be blissful to take note that TCV Panch = 15.
25. Sadhakas fulfilled with intensity of urge to glimpse and imbibe the format and feature of self referral domain (6-space domain) shall glimpse it in the role of origin of 5-space with 4-space boundary and 3-space dimension as a four folds manifestation layers (3, 4, 5, 6) and to permit the transcending mind to glimpse values (3, 4, 5) in terms of corresponding triple formulation (Ek, Dwaya, Triya, Chatur, Panch) accepting transcendental code value range (8, 16, 8, 12, 15).

26. It would further be blissful to visit and revisit seven streams flow from the solid origin of spatial plate of $3 \times 3 = 9$ units.
27. It would further be blissful to chase and reach is formats of hyper cube 5, hyper cube 17 and hyper cube 66.
28. One shall sit comfortably and to permit the transcending mind to chase the manifestation of 6-space content along the format of hyper cubes 1 to 6 as of 1, 2, 3, 4, 5, 6 dimensions and same leading to value $6 \times (1+2+3+4+5+6) = 126 = 63+63$.
29. It would further be blissful to glimpse re-manifestation phenomenon of transcendental content (5-space content) of transcendental domain of hyper cube 5, re-manifesting as 17-space domain.
30. It would be blissful to glimpse and imbibe TCV Aatma = 17 = TCV Divya = TCV Dharvaya = TCV Nand = TCV Shabdh.



NUMBER VALUE 18

1. Number value 18 is of frequency 2^{17} of summation value of choices from values range '1 to 18'.
2. Hyper cube 5 as four folds manifestation layer (3, 4, 5, 6) is of summation value '18'.
3. Value 18 as 18-space, in its different roles brings us face to face with interrelationship of 18-space domain with other spaces in connected roles.
4. Within manifestation layer of hyper cube 17, 18-space plays the role of origin fold, with 15-space as dimension fold, 16-space as boundary fold, 17-space as domain fold and 18-space as origin fold.
5. Values quadruple (15, 16, 17, 18) lead to summation value (66).
6. Value 15 is parallel to TCV value 15 of formulation TEJ (तेज).
7. It is also parallel to the dimensional value of 5 solid dimensions.
8. It is also parallel to transcendental code value 15 of formulation Panch (पंच).
9. It would be a blissful to take note that to reach at formulation of transcendental code value 15.
10. The frequency of transcendental code value 15 is going to be 2^{14} parallel to frequency of choices for making value 15 with choices from values range 1, 2, 3, 4, 5

11. Likewise, the frequency for TCV value 16 is going to be 2^{15} parallel to choices from values range 1, 2, 3, 4, 5, 6.
12. One may have a pause here and take note that values quadruple (14, 15, 16, 17) shall be leading to frequency quadruple $2^{14}, 2^{15}, 2^{16}, 2^{17}$.
13. One may have a pause here and take note that this way we shall be having as many as $2^{14} + 2^{15} + 2^{16} + 2^{17} = 2^{62}$ set up of four folds sequential formulation set up of TCV values (15, 16, 17, 18).
14. One may have a pause here and take note that value 62 is parallel to 62 gaps of 63 points range.
15. Further as that value 63 as value of dimension fold of four folds manifestation layer (63, 64, 65, 66) will bring us face to face with summation value (258).
16. Like that, one will be face to face with the depth of spectrum of manifestation creation along 4x4 grid value 18 accepts accommodation for its different roles as dimension fold of manifestation layers of hyper cubes 17, 18, 19 and 20.

15	16	17	18
16	17	18	19
17	18	19	20
18	19	20	21

17. One may have a pause here and take note that north east diagonal with its quadruple values (18, 18, 18, 18) as values as sequential values of respective dimension fold, boundary fold, domain fold and origin fold, deserves to be comprehended well for its complete imbibing to have full appreciation for proper insight and appropriate enlightenment.

18. One may have a pause here and take note that the north east diagonal as 5 steps long range (18, 18, 18, 18, 18) as of values format of transcendence range: (dimension fold, boundary fold, domain fold, origin fold and base fold) will enrich insight further for dipper enlightenment of the existence phenomenon.
19. One may have a pause here and to take note that with value 18 as of origin of domain 17, shall be leading us to transcendental phenomenon of transcendental content (Divya Darvaya).
20. Like that one can sequentially transcend from value 18 to value 17, and step ahead, from value 17 to value 16, and a step further ahead from value 16 to value 15 and so on.
21. It would be blissful to take note that value 18 is parallel to TCV value 18 of formulation Ishwar (ईश्वर).
22. While value 17 is parallel to transcendental code value 17 of formulation Aatma (आत्मा).
23. Value 16 is parallel to transcendental code value 16 of formulation Jeev (जीव).
24. Value 15 is parallel to transcendental code value 15 of formulation Tej (तेज).
25. Value 14 is parallel to transcendental code value of formulation Satya (सत्य).
26. One can sequentially transcendence further.

27. At each step, one can glimpse the depth of spectrum of sequential transcendental code values set ups of respective frequency of formulation.
28. It would be blissful exercise to glimpse and imbibe the format and values of formulation Hera of transcendental code value 18 of organization $18 = 9+4+3+2$.
29. One may have a pause here and take note that $9 = 4+3+2$.
30. It would further be blissful to take note that value 2 is parallel to spatial order of 4-space.
31. Value 3 is parallel to solid order of transcendental space.
32. Value 4 is parallel to creative order of self referral domain.
33. It would further be blissful to take note that difference value of synthesized quadruple linear dimensions and quadruple spatial dimension is '2'.
34. Further difference of Penta linear dimensional and Penta spatial dimension is $2+3 = 5$.
35. A step ahead, the difference of Hexa linear dimensional and hexa spatial dimensions is $2+3+4 = 9$.
36. One shall sit comfortably and to permit the transcending mind to glimpse further and face to face with synthesis value of Hepta linear dimension and Hepta spatial dimension which comes to be $2+3+4+5 = 14$.
37. One may have a pause here and to take note that value 5 is of middle placement of 9 numerals range.
38. Further, value 5 is interlinked with value 7 as of the format, dimension, domain.
39. It would be blissful to glimpse and imbibe synthesis values equation features $(5, 5) = (7)$.

40. Further, as that, $(7, 7) = (9)$.
41. Still further, TCV (Sapt)(सप्त) = 14.
42. Sadhakas fulfilled with intensity of urge to glimpse and imbibe further shall be face to face with Divya Ganga Paravha (9, 7, 3, 1) along the artifices of Components of sole syllable Om which manifests a solid set up of surface plate ($3 \times 3 = 9$) and volume being $3 \times 3 \times 7 = 63$.
43. It would further be blissful to chase value triple (8, 16, 8) and transcendental code value of triple formulation (एक, द्वय, त्रय).
44. One shall further glimpse and imbibe (8, 12, 15) as transcendental code value triple of formulation (Triya (त्रय), Chatur (चतु), Panch (पञ्च)).
45. A step ahead, one shall glimpse and imbibe the Penta values (10, 14, 11, 17, 10) as transcendental code value of Penta formulations (Sast (षट्), Sapt (सप्त), Asht (अष्ट), Nav (नव), Dash (दश)).
46. One shall further glimpse and imbibe the format feature of eight divisors of number value 30, 12 divisors of number value 60 and 15 divisor of number value 120.
47. One shall further glimpse and imbibe values range 1 to 30 leading to factors 60, double of value 30.
48. It would be blissful to take note that cube (hyper cube 3) is a structural set up of 30 Components (8 corner points, 12 edges, 6 surfaces, 1 volume, 3 dimensions) making a set up of sealed origin.

49. Cube with centre as seat of origin makes it a set up of value 31 which is parallel to the synthesis value of a pair of linear order transcendence range:
[(1+2+3+4+5)+(1)+(1+2+3+4+5)].
50. It would be blissful to take note that $1000 = 961 + 39$.
51. Value 39 is parallel to TCV value of formulation Maheshwara \emptyset .
52. One shall sit comfortably and to permit the transcending mind to continuously remain in prolonged sitting of trans and to be parallel to transcendence phenomenon at centre of the cube / origin of 3-space (4-space in the role of origin of 3-space).



120 YEAR CYCLE

CONTENTS

1. Number value 120
2. Shad Chakra format
3. Geeta study zone
4. Transcendence spectrum of self referral origin
5. Number value 17
6. Number value 18

NUMBER VALUE 120

1. Vedic systems chase existence within human frame as 120 years cycle.
2. Number value '1' as formulation (एक) is of transcendental code value '8'.
3. With it, number value 120 becomes number value $8 \times 120 = 960$.
4. Number value 960 is of organization $960 = 8 \times 10 \times 12$, which is parallel to 960 cubes envelop of entire transcendental boundary of 12 Components with each transcendental Component itself being within 10 creative Components and every creative Components itself is enveloped by 8 solid Components.

960 CUBES ENVELOPS

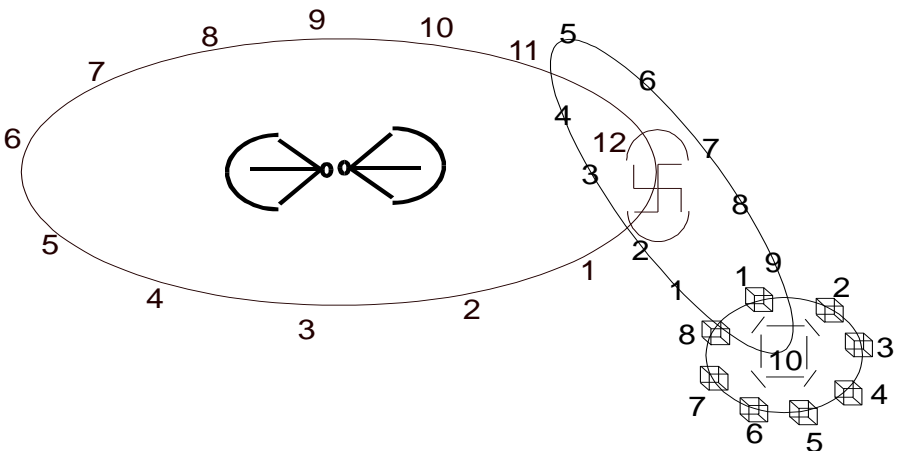

5. One shall sit comfortably and to permit the transcending mind to glimpse and imbibe the values and features of above organization of self referral domain (6-space domain) within transcendental boundary (5-space in the role of boundary of 6-space domain) of 12 Components and each transcendental boundary Component (5-space as boundary Component) is enveloped within creative boundary (4-space as boundary of 5-space) of ten Components and each creative Components (4-space) itself being enveloped within solid boundary (3-space as boundary of 4-space) of eight Components.



2

SHAD CHAKRA FORMAT

1. Vedic scripture preserves the enlightenment as that human frame is of shad chakras of external characteristics (2, 4, 6, 8, 10, 12, 14) respectively.
2. One may have a pause here and take note that these features and values of shad chakras are parallel to boundary Components of hyper cubes 1 to 6, the representative regular bodies of 1 to 6-space within 4-space along the format of idol of lord Brahma, creator's supreme., together synthesis Sathapatya measuring rod presided by lord Vishnu, over lord of 6-space while lord Brahma, over lord of real 4-space is the presiding deity of the measuring of this measuring rod.

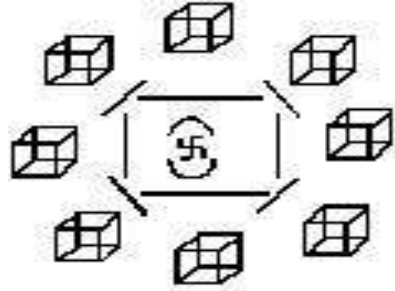

- One shall sit comfortably and to permit the transcending mind to glimpse and imbibe the features of shad chakras and of Sathapatya measuring rod as a synthetic set up of four folds manifestation layer ($N, N+1, N+2, N+3$) for $N = 1, 2, 3, 4, 5, 6$, and value N being the value of N -space domain of hyper cube N in the role of dimension of hyper cube $N+2$.

Hyper cubes 1 to 6					
1	2	3	4	5	6
—	□	3D cube	3D cube with arrows	Swastika	(→←)

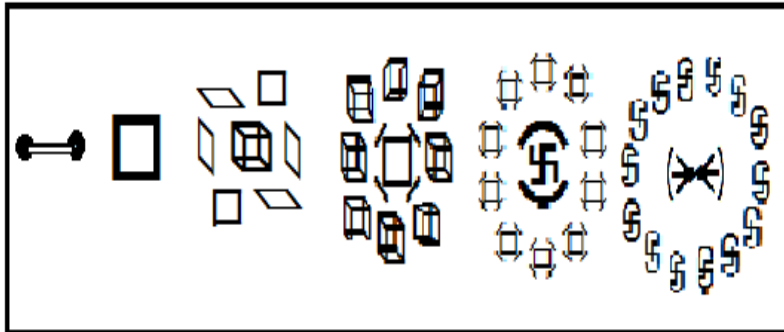

4. It would be blissful to take note that these four folds manifestation layer of hyper cubes 1 to 6 are accommodated by 4x6 grids.

-1	0	1	2
0	1	2	3
1	2	3	4
2	3	4	5
3	4	5	6
4	5	6	7

5. One may further have a pause here and take note that all the 24 double digit number of 5 place value systems are accommodated by 4x6 grid:

01	02	03	04	
10	11	12	13	
14	20	21	22	
23	24	30	31	
32	33	34	40	
41	42	43	44	100

6. It would further be blissful to take note that 4x4 grid accommodates all the 16 folds of quadruple manifestation layer of hyper cubes 1, 2, 3 and 4.

1	2	3	4
2	3	4	5
3	4	5	6
4	5	6	7

7. Further, 5x5 grid accommodates all 25 folds of transcendence range of linear, spatial, solid, creative and transcendental order.

1	2	3	4	5
2	3	4	5	6
3	4	5	6	7
4	5	6	7	8
5	6	7	8	9













8. A step ahead, 6x6 grid accommodates all 36 folds of hexa self referral ranges:

1	2	3	4	5	6
2	3	4	5	6	7
3	4	5	6	7	8
4	5	6	7	8	9
5	6	7	8	9	10
6	7	8	9	10	11

9. One may have a pause here and take note that above 4x4 grid of 16 folds of hyper cubes 1 to 4 lead to grand summation value 4^3 .
10. Further, above 5x5 grid of 5 folds transcendence ranges leads to grand summation value 5^3 .
11. Further, above 6x6 grid of hexa folds ranges leads to grand summation value 6^3 .



GEETA STUDY ZONE

Srimad Bhagwad Gita Study - Zone :											
$\frac{a}{2}$	$\frac{a^2}{4a}$	$\frac{a^3}{6a^2}$	$\frac{a^4}{8a^3}$	$\frac{a^5}{10a^4}$	$\frac{a^6}{12a^5}$	$\frac{a^5}{10a^4}$	$\frac{a^2}{8a}$	$\frac{a^3}{6a^2}$	$\frac{a^4}{4a^2}$	—	
											
2x1 =2	4x2 =8	6x3 =18	8x4 =32	10x5=50 50x7=350		10x5=50 50x7=350	8x4 =32	6x3 =18	4x2 =8	2x1 =2	
Orbitals :				350+350=700							
2	6	10	14	18=5+6+7							

1. One shall sit comfortably and to permit the transcending mind to glimpse and imbibe values and features of above organization format of approach to 6-space domain from both ends.
2. Srimad Bhagwad geeta is a scripture of 700 shalokas ranges.
3. It is a scripture of 18 chapters.
4. Formulation Shad Chakras is of transcendental code value 18 which is of organization as 18 = 3+4+5+6 parallel to which is four folds manifestation layers (3, 4, 5, 6) of hyper cube 5, with self referral origin (6-space as origin).

5. The organization of srimad Bhagwad Geeta is that its first nine chapters are of total shalokas range 350+22 while chapters 10 to 18 are of shalokas range 350-22.
6. One may have a pause here and take note that value 22 is of organization $22 = 4+5+6+7$, which is parallel to four folds manifestation layers (4, 5, 6, 7) of hyper cube 6.
7. One shall sit comfortably and to permit the transcending mind to glimpse and imbibe these values and features of the organization format of text of Srimad Bhagwad Geeta and values and features of 6th chakra of human frame being of 12 external characteristics parallel to transcendental boundary of 12 Components of hyper cubes 6, the representative regular body of 6-space.



4

TRANSCENDENCE SPECTRUM OF SELF REFERRAL ORIGIN

1. Transcendental domain (5-space domain) has self referral origin (6-space origin).
2. Self referral origin (6-space origin) transcends out from the transcendental domain and makes a transcendence spectrum (5, 6, 5) and as a result transcendental domain splits into a pair of transcendental domains.
3. One may have a pause here and take note that transcendence spectrum (5, 6, 5) is of summation value $5+6+5 = 16$, which

is parallel to transcendental code value 16 of formulation (जीव) Jeev.

4. One may have a pause here and take note that value 16 as 16-space in the role of dimension leads to transcendental range (16, 17, 18, 19, 20) of summation value 90.
5. One may have a pause here and take note that Vedic systems chase of existence phenomenon of (जीव) within human frame has 9 (ग्रह) is of years cycles (6, 7, 7, 10, 16, 17, 18, 19, 20) of summation value 120.
6. Sadhakas fulfilled with intensity of urge to glimpse and imbibe the feature of this organization of 120 years cycle as 9 cycles of (6, 7, 7, 10, 16, 17, 18, 19, 20) cycles shall sit comfortably and to permit the transcending mind to glimpse and imbibe the features and values of existence phenomenon of (जीव)/Jeev being within Shreer / body (शरीर).
7. One may have a pause here and take note that TCV (शरीर) = 14 and TCV (जीव) = 16.
8. One may further have a pause here and take note that value 14 accepts organization as $14 = 2+3+4+5$, which is parallel to four folds manifestation layer 2, 3, 4, 5 of hyper cube 4, the representative regular body of 4-space itself, while value $16 = 2^4$ is parallel to the value of dimensional frame of quadruple spatial dimensions of 4-space.
9. One may further have a pause here and take note that $0+0 = 0 = 0 \times 0 = (-0) \times (-0)$ and $2+2 = 4 = 2 \times 2 = (-2) \times (-2)$ and as such, it is not only the addition and multiplication operations

- but also the reversal of orientation of features as well get absorbed within the spatial order which itself is of zero order.
10. One may further have a pause here and take note that (-14) space domain splits into a pair of dimensions of value (-16) space.
 11. With it, the domain split spectrum quadruple value (6, 4, 4, 2) deserves to be comprehended well for the 6-space domain.
 12. With it, the chase of domain split spectrum (14, 16, 16) as (14+16, 16) will bring us face to face with the existence phenomenon of Jeev within Shreer as of value 14+16 = 30, and the existence phenomenon of jeev itself as transcendence range 16, 17, 18, 19, 20 of summation value 90, deserves to be comprehended well.
 13. Further, value 14 = TCV (Sapt), as such will help us comprehend the organization of value 30 as (6, 14, 10) and further it being (6, 7, 7, 10).
 14. One may have a pause here and take note that value 6 is of organization $6 = 0+1+2+3$, which is parallel to four folds manifestation layer (0, 1, 2, 3) of hyper cube 2, while value 10 = $1+2+3+4$, parallel to four folds manifestation layer (1, 2, 3, 4) of hyper cube 3 and $14 = 2+3+4+5$, parallel to 2, 3, 4, 5 of hyper cube 4.
 15. One shall sit comfortably and to permit the transcending mind to glimpse values range (6, 7, 7, 10, 16, 17, 18, 19, 20) as 9 cycles of 9 (ग्रह) with TCV (ग्रह) = 15.

16. One may have a pause here and take note that there are 9 (स्वर) and formulation (स्वर) is of transcendental code value 15.
17. Further value 15 is parallel to $15 = 1 \times 3 \times 5$, the value of dimensional frame of transcendental domain (5-space).
18. It would be a blissful exercise to glimpse and imbibe above values and features.
19. One shall sit comfortably and to permit the transcending mind to glimpse (तेज) 15 is value of constituent of dimension (16).
20. Further, one shall sit comfortably and to glimpse and imbibe (प्रकाश) TCV = 13, as dimension of (तेज) TCV = 15.
21. It would be blissful to glimpse and imbibe Shreer (TCV = 14) as existence phenomenon of in between (प्रकाश) TCV = 13, and (तेज) TCV = 15.
22. One shall sit comfortably and to revisit values range (6 to 20), the 15 steps long range parallel to dimensional frame of transcendental domain of value (15).
23. It would be blissful to take note that $120 = 15 \times 8$ and TCV (EK) = 8 and TCV (Panch) = 15.
24. With it, the organization becomes the organization of (एक) and (पंच), and of 5 value systems, 4x6 grid and value $24 =$ TCV (पुरुष).



FEATURES OF VALUES RANGE 16, 17, 18, 19, 20 & OF VALUE 120

5

NUMBER VALUE 17

1. Number value (17) is a prime value.
2. Value 17 is parallel to 17 geometries range of 8-space.
3. Further it is parallel to 17 versions of hyper cube 8.
4. One may have a pause here and take note that four folds manifestation layers (6, 7, 8, 9) of hyper cube 8, is having Brahman origin (9-space in the role of origin of 8-space).
5. One may have a pause here and take note that 9 points range has 8 gaps and this as such, makes a set up of $9+8 = 17$ structures.
6. It would be blissful to take note that values pair (9, 8) accepts organization (3^2 , 2^3) and this organization as such, is organization of vertical reflection pairing as pair of digits (3, 2) swap their places with a shift from base to index and other way round as well.
7. One shall sit comfortably and to permit the transcending mind to glimpse and imbibe the values and features of value number (17).
8. Number value 17 is parallel to transcendental code value 17 of formulation Rahu (राहु).
9. It will be blissful to take note that Rahu Graha (राहु, गृह) has 17 years cycle in the organization of 120 year cycle.

10. It would further be blissful to take note that formulation Aatma is also of transcendental code value (17).
11. One shall sit comfortably and to permit the transcending mind to glimpse and imbibe these features to acquire proper insight and to attain appropriate enlightenment about the role of 'Rahu' (राहु) in the 120 years cycle of existence phenomenon with in human frame of shad chakra format.
12. Sadhakas fulfilled with intensity of urge to acquire proper insight and to attain appropriate enlightenment about the existence phenomenon within human frame shall known more and more about 'Rahu (राहु, गृह).
13. Formulation (गृह) ghara is of transcendental code value 15.
14. Values pair (17, 15) is of the format (17 as domain, 15 as dimension).
15. Further, value 15 is parallel to transcendental code value 15 of formulation Tej (तेज).
16. Further value 15 is parallel to value of dimensional frame of 5 solid dimensions of transcendental domain (5-space domain).
17. One may have a pause here and take note that bodily format of (Rahu) is of 'Head' uptill through.
18. It would be blissful to take note that through is the seat of fifth chakra.
19. Further, TCV (Rahu Garha) ($17+15 = 32 = 2^5$ is parallel to 32 being the frequency of reach at summation value '6' of choices from values range (1, 2, 3, 4, 5, 6).
20. It would be blissful to reach at following 32 frequency for value 6 of choices from the values range (1, 2, 3, 4, 5, 6)

(i) $6 = 1+1+1+1+1$, (ii) $6 = 2+1+1+1+1$, (iii) $6 = 1+2+1+1+1$, (iv) $6 = 1+1+2+1+1$, (v) $6 = 1+1+1+2+1$, $6 = 2+1+1+1+1$, (vi) $6 = 1+1+1+1+2$, (vii) $6 = 1+1+2+2$, (viii) $6 = 1+2+1+2$, (ix) $6 = 2+1+1+2$, (x) $6 = 2+2+1+1$, (xi) $6 = 2+1+2+1$, (xii) $6 = 1+2+2+1$, (xiii) $6 = 2+2+2$, (xiv) $6 = 1+1+1+3$, (xv) $6 = 1+1+3+1$, (xvi) $6 = 1+3+1+1$, (xvii) $6 = 3+1+1+1$, (xviii) $6 = 3+2+1$, (xix) $6 = 3+1+2$, (xx) $6 = 2+1+3$, (xxi) $6 = 2+3+1$, (xxii) $6 = 1+3+2$, (xxiii) $6 = 1+2+3$, (xxiv) $6 = 3+3$, (xxv) $6 = 4+1+1$, (xxvi) $6 = 1+4+1$, (xxvii) $6 = 1+1+4$, (xxviii) $6 = 4+2$, (xxix) $6 = 2+4$, (xxx) $6 = 1+5$, (xxxi) $6 = 5+1$, (xxxii) $6 = 6$

21. One shall sit comfortably and to permit the transcending mind to glimpse and imbibe these values and features.

■

6

NUMBER VALUE 18

1. Number value 18 accepts organization $18 = 3+4+5+6$, which is parallel to four folds manifestation layers (3, 4, 5, 6) of hyper cube 5.
2. Number value 18 is parallel to transcendental code value 18 of formulation Parkarti (प्रकृति).
3. One may have a pause here and take note that (बुध्) has 18 years periodic organization.
4. Formulation (बुध्) is of transcendental code value (24).

5. One may have a pause here and take note that value (18) is of placement in between values pairs (17, 19).
6. One may further have a pause here and take note that $24 = 18 \times 4/3$.
7. One shall sit comfortably and to permit the transcending mind to glimpse and imbibe these values and features.
8. One may further have a pause here and take note that 6-space plays the role of origin of 5-space. Further as that, 5-space is a solid order (3-space in the role of dimension of 5-space) space while 6-space is of creative order (4-space in the role of dimension of 6-space).
9. One may further have a pause here and take note that value 17 is parallel to the placement value of northern hemisphere.
10. Value 19 is parallel to placement value of southern hemisphere.
11. One shall sit comfortably and to permit the transcending mind to glimpse and imbibe these values and features of the organization format of values triple (17, 18, 19).
12. It would further be blissful to take note that re-manifestation will brings us face to face with hyper cube 18 as a four folds manifestation layer (16, 17, 18, 19) of summation value 70 which is parallel to the domain split spectrum at fifth split: (1, 2, 5, 12, 29, 70, ...).
13. One may further have a pause and take note that four folds manifestation layer (16, 17, 18, 19) transit and transform into 5 folds transcendence range (16, 17, 18, 19, 20) of summation value '90' parallel to summation value of cyclic period of

Breshpati (बृह), Rahu (रह), Budh (बुध), Shani (शनि), Shukra (शुक्र) of respectively (16, 17, 18, 19, 20) years cycles in the organization of 120 years cycles.

14. It would be blissful to take note that TCV (Breshapti) = 36, TCV (Rahu) = 17, TCV (Budh) = 16, TCV (Shani) = 13, TCV (Sukar) = 8.
15. It would be blissful exercise to be face to face with the values range (36, 17, 24, 13, 8) of TCV values and (16, 17, 18, 19, 20) of cyclic period.
16. It will bring us face to face with following five values pairs (1) 36, 16, (17, 17), 24, 18, (13, 19), and (8, 20).
17. One may have a pause here and take note that:
 - (i) Value pair 13, 16 bring us face to face with organization 6^2 , 4^2 and that 4-space plays the role of dimension of 6-space.
 - (ii) 17, 17 is of natural features of equal values pair.
 - (iii) 24, 18 is of organization 24, $18 \times 4/3$.
 - (iv) 13, 19 with $13+19 = 32 = 2^5$ and $19-13 = 6$, bring us face to face with the features and values of value 6 parallel to 6-space domain of hyper cube 6 of 13 versions and values pairs 13, 19 as end pairs of value 13, 14, 15, 16, 17, 18, 19 of seven steps long range parallel to seven non negative geometry of 6-space.
 - (v) 8, 20 with its organization (4, 4) (10, 10) its further brings us face to face with $4 = 1+1+1+1$, $10 = 1+2+3+4$.

18. One may have a pause here and take note that value 20 is parallel to synthesis value of a pair of transcendental ranges of zero order.
19. Further, value 20 is parallel to transcendental code value 20 of formulation Ved as well as of formulation Dev (०).
20. Still further, value 20 is the summation value of synthesis values of single double, triple and quadruple values of same order, and bring of whole range of orders.
21. It would further be blissful to take note that value 120 accepts (1, 2, 3, 4, 5, 6, 8, 10, 12, 15, 20, 24, 30, 60, 120) as factors.
22. One shall sit comfortably and to permit the transcending mind to glimpse and imbibe this feature of values 120 accepting 15 factors.
23. It would be blissful to take note that TCV (Ek) (एक) = 8 and TCV (Panch)(पंच) = 15.
24. One shall sit comfortably and to permit the transcending mind to glimpse and imbibe these values and features.



CONTENTS

3. Formulation NAV to EK
4. Visphot Dhavani

FORMULATIONS NAV TO EK

S. No	Formulation	TCV	Relationship
1	नव	17	$9+8$
2	अष्ट	11	$(8, 9, 10, 11)$
3	सप्त	14	$(11, 12, 13, 14)$
4	षट्	10	$14 = 2+3+4+5$ $10 = 1+2+3+4$
5	पञ्च	15	$1+2+3+4+5 = 15$
6	चतुर्	12	$15 = 3+3+3+3+3$ $12 = 3+3+3+3$
7	त्रय	8	$8, 9, 10, 11, 12$
8	द्वय	16	$8 = 2+2+2+2$ $16 = 4+4+4+4$
9	एक	8	$16 = 4+4+4+4$ $8 = 2+2+2+2$
10	दश	10	$8 = 2+2+2+2$ $10 = 2+2+2+2+2$



VISPHOT DHAVANI

(विस्फोट ध्वनि)

1. Formulation (विस्फोट) accepts transcendental code value 29.
2. Formulation (ध्वनि) accepts transcendental code value 25.
3. Formulation (विस्फोट ध्वनि) and formulation (ध्वनि विस्फोट) accepts TCV value 54 each.
4. The pair of values (25, 29), as such, make a end pair values of transcendence range (25, 26, 27, 28, 29) of summation value $25+26+27+28+29 = 27 \times 5 = 135$, which avails triple digits (1, 3, 5) parallel to format of (1-space, 3-space, 5-space) manifesting a transcendence range of transcendental domain (5-space domain) with 3-space in the role of dimension and 1-space in the role of dimension of dimension.
5. Formulation (विस्फोट) with transcendental code value 29 is parallel to domain split spectrum of its fourth stage split value 29.
6. One may have a pause here and take note that value 29 is parallel to TCV value of 29 of formulation (ब्रह्मा).
7. Lord Brahma is the over lord of real 4-space and idol of lord brahma is of format and feature of hyper cube 4, the representative regular body of 4-space with transcendental origin (5-space as origin).
8. One may further have a pause here and take note that first stage split of domain N leads to quadruple constitutions spectrum (N, N-2, N-2, N-4).

9. The next stage split leads to split spectrum of ten constituents (N, N-2, N-2, N-4, N-4, N-4, N-4, N-4, N-6, N-6).
10. At next stage, domain split spectrum is of 25 constituents: (N, N-2, N-2, N-4, N-4, N-4, N-4, N-4, N-6, N-6, N-6, N-6, N-6, N-6, N-6, N-6, N-6, N-6, N-8, N-8, N-8, N-8, N-8, N-8).
11. One may have a pause here and take note that sequential split of domain leads to spectrum stream (1, 2, 5, 12, 29, ...).
12. Further, the reach of the range of streams (1, 2, 3, 5, 12, 29), as such remains constituents set ups (1, 2, 5, 12, 5) of summation value 25.
13. It is this features and values which deserves to be comprehended well.
14. It is this phenomenon which is the phenomenon of (विस्फोट (29), ध्वनि) (25).
15. One shall sit comfortbalt and to permit the transcending mind to continuously remain in prolonged sitting of trans and to glimpse and imbibe the phenomenon of (विस्फोट (29), ध्वनि) (25), as domain split spectrum:

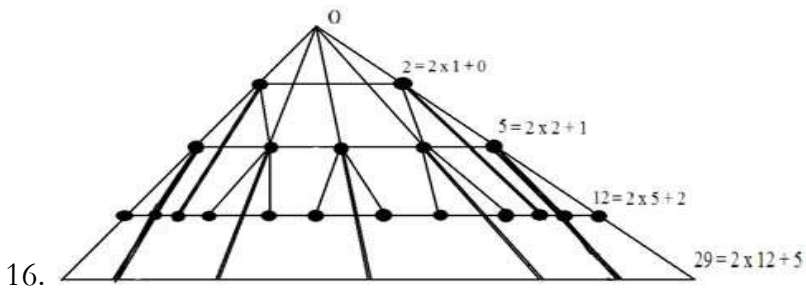

17. It would further be a very blissful exercise to glimpse and imbibe the organization of value 29 as $29 = 14+15$ which is parallel to summation value of four folds manifestation layer (2, 3, 4, 5) and of the dimensional value of solid dimensional frame of 5 dimensions of transcendental domain in the role of origin of 4-space.

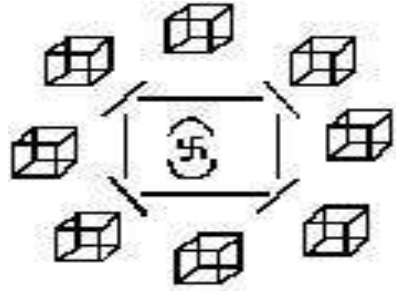

18. One may further have a pause here and to permit the transcending mind and to glimpse and imbibe the values and features of formulation (वाक्य पदीम्) which accepts transcendental code value $12+25 = 37$.
19. It would be blissful to take note that $25 = 2 \times 12 + 1$ and $37 = 2 \times 18 + 1$ and value 25 is parallel to transcendental code value of formulation Vishnu (विष्णु) while value 37 is parallel to transcendental code value of formulation Sri Bhagwan (श्रीभगवान्)

